

FORD TRANSIT CONNECT



THE SIMPLE WAY TO DRIVE A NEW FORD TRANSIT CONNECT

1 EXPLORE

2 SELECT

3 CUSTOMISE

4 SPECIFICATIONS

5 PURCHASE



Unlock the interactive brochure
online

Transit Connect Van Sport L1 in Chrome Blue metallic body colour (option).



1 EXPLORE

WORK SMARTER

Functionality is key to the Ford Transit Connect. So, you'll find a versatile and easily-accessible loadspace, a choice of wheelbase lengths and a comfortable driving environment, all wrapped in a bold, stylish shape.

Designed from the very start as a hard-working commercial vehicle, Transit Connect combines legendary Ford Transit toughness with innovative features and advanced technologies, to help you stay connected and in control.

Transit Connect Van Active L2 in Frozen White solid body colour with 17" 5-spoke Absolute Black alloy wheels (standard) and Van Limited L1 in Chrome Blue metallic body colour (option) with 16" 5x2-spoke Sparkle Silver alloy wheels (standard).



1 EXPLORE

DRIVING CONFIDENCE

MECHANICAL LIMITED-SLIP DIFFERENTIAL

Transit Connect's mechanical limited-slip differential can help reduce unwanted wheelspin, especially on loose surfaces. By automatically directing torque to the wheel with the most grip, it enhances Transit Connect's front-wheel drive capability and delivers even greater levels of traction, stability and composure in more challenging conditions. (Option)



Transit Connect Van Active L1 in Frozen White solid body colour with 17" 5-spoke Absolute Black alloy wheels.

TAKE CONTROL

YOUR OFFICE ON THE ROAD

Spend just a moment in Transit Connect's comfortable, well-crafted cabin and you'll know that it was built for you. All the controls are logically placed and incorporated into the overall design of the interior, helping to make every action smooth, intuitive and efficient.

As well as being both practical and durable, its clever design provides plenty of useful storage too. And with a range of smart technologies at your fingertips, including the latest available Ford SYNC 3* (standard on Active, option on other series), Transit Connect can happily serve as your connected mobile office.

*Don't drive while distracted. Use voice-operated systems when possible; don't use handheld devices while driving. Some features may be locked out while the vehicle is in gear. Not all features are compatible with all phones.

Transit Connect Van Limited L1 with Ligne in Dark Palazzo Grey and Marl/City Fabric in Ebony bolster.





1 EXPLORE

MEET YOUR PHONE'S NEW BEST FRIEND

FORD SYNC 3

Available Ford SYNC 3 integrates seamlessly with your smartphone, letting you control everything from phone calls and text messaging to music and satellite navigation – all via the 6" touchscreen or through remarkably simple voice commands*. Map updates help to keep you on track and on time, and are complimentary for a limited period following vehicle registration. (Option with Navigation)

SYNC 3 FEATURES*

- Manage your phone, music, apps and navigation with simple voice commands
- Hear your text messages read aloud for you
- Emergency Assistance† helps occupants place an emergency call to provide emergency services with the vehicle location in their respective language
- Control SYNC-compatible apps with AppLink, while Apple CarPlay and Android Auto let you navigate your smartphone through the SYNC 3 home screen, as if it were your handset
- Colour touchscreen supports multi-touch 'swipe' and 'pinch-to-zoom' gestures

Please note: Full SYNC 3 smartphone integration is only available with iPhone 5/Android 5.0 (Lollipop) or higher. Some SYNC 3 functions require a data connection, so mobile data charges will apply. To check whether Apple CarPlay and Android Auto are available in your market, please check their official websites for the latest information.

*Don't drive while distracted. Use voice-operated systems when possible; don't use handheld devices while driving. Some features may be locked out while the vehicle is in gear. Not all features are compatible with all phones.

†Ford Emergency Assistance is an innovative SYNC feature that uses a Bluetooth®-paired and connected mobile phone to help vehicle occupants initiate a call to the local Communications Centre, following a vehicle crash event involving an airbag deployment or fuel pump shut off. The feature operates in more than 40 European countries and regions.



1 EXPLORE

100% CONNECTED

Only Ford can deliver a fully-connected ecosystem that's built-in from the start. Ford has a comprehensive suite of connected services to help your business thrive, no matter how many vehicles you own.

FORDPASS PRO

Whether you work with one business vehicle or manage up to five, FordPass Pro gives you the tools you need to help keep them healthy, secure, and running smoothly.

- **Quick Setup** Use your phone's camera to add up to five vehicles to your account through the app using the vehicles' VIN numbers
- **Vehicle Health** Manage your vehicles' health in real-time
- **Health Alerts** Increase your awareness of vehicle health
- **Fleet Health on Map** See all of your vehicles on a single map with their health status visible. Check your fleet at the start and end of the working day
- **Remote Lock and Unlock** Zonal Locking allows you to remotely access different areas of your vehicle, e.g. side load door, driver's door, etc
- **Remote Start** Get your fleet ready for business at the start of the day and heat or cool the cabin as required (models with automatic transmission only)
- **Guard Mode** Set your vehicle in a heightened state of security and receive notification of any activity with your vehicle
- **Roadside Assistance** Keep your fleet up and running with roadside assistance when you need it
- **Online Service Booking** Check your Dealer's availability and book your service direct from the app

Download **FordPass Pro** from the App Store or get it on Google Play.



FORDPASS CONNECT

- **Live Traffic**** Sends up-to-date traffic information directly to the SYNC 3 Navigation system. The technology then adjusts the recommended route based on the traffic conditions, so you waste less time on the way to your next job
- **Local Hazard Information**** Uses multiple local and national information sources to warn you of hazards on the road ahead
- **On-board Wi-Fi***** With speeds of up to 4G, on-board Wi-Fi enables mobile working for up to 10 devices. You can even use the hotspot from up to 15 m outside the vehicle for more efficient mobile working when you get to the site

FORD DATA SERVICES†

With Ford Data Services and FordPass Connect you can receive vehicle data securely to either your own telematics application or via your chosen Telematics Service Provider. Data available includes: vehicle health, vehicle location, fuel usage and driving characteristics, and can be received on multiple vehicles. Data can be integrated with your existing in-house application or your chosen Telematics Service Provider.

FORD TELEMATICS‡

With Ford Telematics and FordPass Connect you can easily view data and manage all your vehicles using our intuitive user dashboard. Receive data on multiple vehicles including: vehicle health, vehicle location, fuel usage and driving characteristics. The information is presented with actionable insights that deliver the data you need to manage your fleet.

Note If you operate up to five Ford vehicles you should use FordPass Pro. If you have more than five vehicles, then we recommend using Ford Data Services[†] and Ford Telematics[‡].

Note FordPass Pro is a free app, compatible with select smartphone platforms and is available via download. Future features may be chargeable and message and data rates may apply.

*The FordPass Connect on-board modem will be connected at the time of vehicle delivery. You may choose to opt in/out of certain data sharing. The technology will be made available in selected markets in 2019, with the remaining markets following through 2020. Remote access features will be free for the life of the vehicle (10 years).

**Live Traffic and Local Hazard Information access is complimentary for 12 months following the registration of a new Ford featuring SYNC 3 Navigation; thereafter a subscription is payable. Local Hazard Information is subject to availability at time of purchase.

***Wi-Fi hotspot (up to 4G LTE) includes a complimentary wireless data trial for a limited time only that begins at time of activation. Afterwards, data bundles can be purchased from Vodafone. Please refer to their website for details of their data packages. To take advantage of the built-in Wi-Fi hotspot capability, Ford vehicles must come with the appropriate hardware, and a data plan is required. Data coverage and service is not available everywhere and terms of your data plan, including applicable message and data rates, may apply.

†Ford Data Services and Ford Telematics are available for Ford vehicles with a FordPass Connect modem or a Ford plug-in modem. Fleet/business customers only. Subscription charges and Ford Connected Service terms and conditions apply.

FordPass Pro is available in selected markets. Please see your Ford Dealer for details.



EXPLORE

LOAD IT

EASY ACCESS FOR LOADING AND UNLOADING

Transit Connect Van provides an impressive 2.9 cubic metres of loadspace in the short wheelbase (L1) version behind its full-height, full-width glazed or unglazed steel bulkhead. The long wheelbase (L2) model offers up to 3.6 cubic metres*.

Wide-opening rear doors and side load door (option on Van Base) are optimised for their opening heights, and combine with a low floor height for effortless access to the loadspace.

- **180-degree opening rear doors** can be securely latched at 90-degrees for safer working in high winds, or when loading on a sloped surface (standard)
- **Load-through bulkhead** provides floor-level access to the additional storage space beneath the front passenger seat. This allows you to transport longer items, such as pipes or posts of up to 3.0-metres in length in L1 Van, or 3.4-metres in L2 Van (option)
- **Sliding kerb side load door** offers easy access to the loadspace (option on Van Base, standard on Trend and above)
- **Twin sliding side load doors** for even greater loading versatility (option on Van, standard on Double Cab-in-Van)

*Cargo and load capacity limited by weight and weight distribution.

Transit Connect Van Limited L1 in Solar Silver metallic body colour (option). Vehicle shown features accessories, available at extra cost.

BIG ON SPACE, BIG ON CHOICE

OPTIMISED LOADSPACE

Choose from two wheelbase lengths and three bodystyles to create a load capacity from 1.2 cu.m to 3.6 cu.m[†], with potential payloads of up to 982 kg*.

- Full-height, full-width glazed or unglazed steel bulkhead (Van)
- Full-height, full-width mesh bulkhead (Double Cab-in-Van)
- Load-through bulkhead can accommodate 3.4-metre long items (L2 Van), or 3.0-metre long items (L1 Van) (option in conjunction with dual passenger seat)
- Room for up to four 8'x4' boards (L2 Van)
- Sliding kerb side load door (option on Van Base, standard on Trend and above)
- Twin sliding side load doors (option on Van, standard on Double Cab-in-Van)
- Single front passenger seat (Van)
- Two first row seats and three second row seats (Double Cab-in-Van L1)

3.0 m/3.4 m

Load length with load-through bulkhead

Carry items up to 3.0 metres long in the L1 Van with the ingenious load-through bulkhead. L2 models can hold 3.4-metre long items. (Option)



EASY LOADSPACE ACCESS

Access to the flexible loadspace is easy, thanks to wide-opening doors and a low loading height.

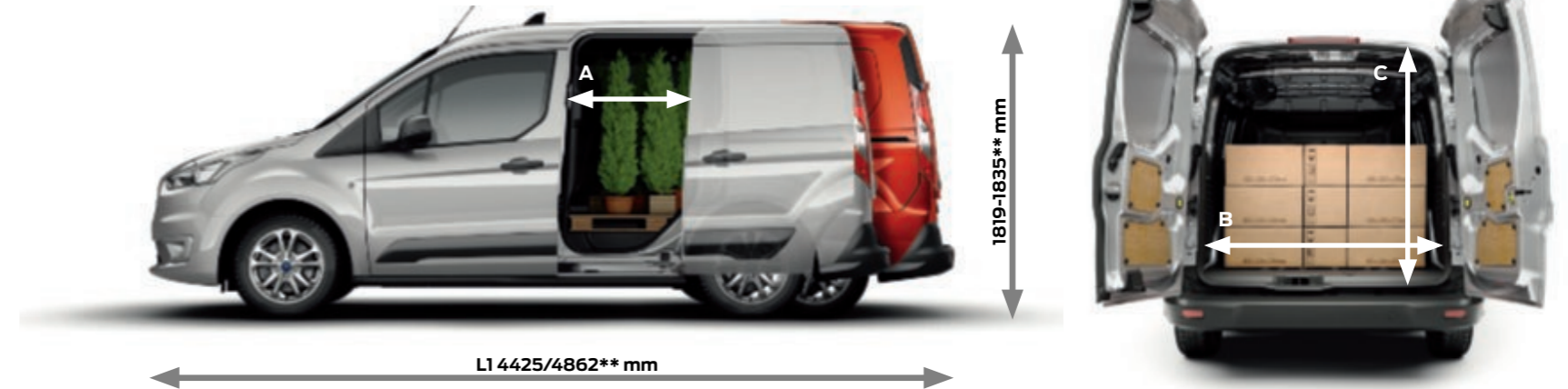

250,000 DOOR SHUTS

We opened and closed the doors over 250,000 times in non-stop endurance tests to help ensure they will never let you down.

[†]SAE method.
 *Maximum payload varies and is based on accessories and vehicle configuration. See label on door jamb for carrying capacity of a specific vehicle.
 **Figures shown are van bodystyle, please see specifications table for additional information.

1 EXPLORE

Van Short Wheelbase (L1)

2.9
cu.m†



Europallet x1
2 Seats



Max. gross payload up to 982 kg*
Gross vehicle mass from 2,090 kg to 2,501 kg



Flexible passenger's seat

The centre seat folds flat and has a lift-up cushion and underseat storage. The outer seat base folds cinema-style so tall items may be carried. (Option on Van)

Van Long Wheelbase (L2)

3.6
cu.m†



Europallet x2
2 Seats



Max. gross payload up to 961 kg*
Gross vehicle mass from 2,165 kg to 2,501 kg



8'x4' bulkhead

L2 Van models can carry up to four 8'x4' sheets of material against a specially-designed steel bulkhead. (Standard on Van)

Double Cab-in-Van Short Wheelbase (L1)

1.2
cu.m†



Europallet x1
5 Seats



Max. gross payload up to 781 kg*
Gross vehicle mass from 2,425 kg to 2,385 kg



Movable mesh bulkhead

Full mesh bulkhead separates loadspace and passenger space, and offers a choice of configurations to suit your changing needs. (Standard on Double Cab-in-Van)

Double Cab-in-Van Long Wheelbase (L2)

1.6
cu.m†



Europallet x1
5 Seats



Max. gross payload up to 775 kg*
Gross vehicle mass from 2,165 kg to 2,445 kg

†SAE method.

*Cargo and load capacity limited by weight and weight distribution. Maximum payload varies and is based on accessories and vehicle configuration. See label on door jamb for carrying capacity of a specific vehicle.

Europallet 1,200 mm x 800 mm.



LOAD UP AND GO

PEOPLE, CARGO OR BOTH

The versatile Ford Transit Connect Double Cab-in-Van offers comfortable seating for up to five people, plus cargo space for tools, equipment or goods. Dual sliding side load doors make it easy for your work crew to get in and out, while wide-opening, glazed rear cargo doors provide unrestricted access to the generous loadspace.

With its resourceful character, the adaptable Transit Connect Double Cab-in-Van provides the transport flexibility your business demands.



Vehicle shown features accessories, available at extra cost.

Transit Connect Double Cab-in-Van L2 in Solar Silver metallic body colour (option).



1 EXPLORE

MAXIMUM VERSATILITY

TRANSIT CONNECT DOUBLE CAB-IN-VAN

If moving people and their tools or belongings is your business, then Transit Connect Double Cab-in-Van is versatile enough to keep up with everything that comes your way.

Its comfortable five-seat crew cab and adaptable loadspace mean you can take your work team on site with their tools and equipment stored safely behind the movable mesh bulkhead. It also offers the added flexibility of being able to fold or remove the rear seats to maximise the loadspace when transporting bulky tools, equipment or goods*.

- **Easy access** to the rear seats is provided through the wide-opening sliding side load doors (standard)
- **Flexible rear seats** can tumble forward or be removed entirely for maximum loadspace
- **Movable mesh bulkhead** separates the passenger compartment from the loadspace (standard)
- **Dual rear cargo doors** provide easy access to the rear of Transit Connect's loadspace (standard)
- **Glazed rear tailgate** is available as an option

*Cargo and load capacity limited by weight and weight distribution.

Transit Connect Double Cab-in-Van Trend L2 with Capitol in Ebony/City Fabric in Ebony.



1 EXPLORE

DRIVING EXPERIENCE

Transit Connect comes with a range of advanced technologies designed to enhance your driving experience. From Intelligent Speed Assist with Traffic Sign Recognition⁽²⁾ that can automatically detect the current speed limit (when activated) and then adjust your maximum speed setting to that limit, to Distance Indication⁽²⁾ that displays the distance to the vehicle ahead, Transit Connect enables you to concentrate on the road ahead.



Intelligent Speed Assist with Traffic Sign Recognition⁽²⁾

Detects speed limits, including variable limits, and no-overtaking signs via the forward-facing camera and shows them in the cluster display. Intelligent Speed Assist uses the information to help you keep within the prevailing speed limit⁽¹⁾. (Option)



Distance Indication⁽²⁾

An instrument cluster display continuously indicates the distance to the vehicle in front. The system illuminates a system of coloured icons depending on the proximity settings you've chosen. Distance Alert can notify you with a red warning symbol if you get too close to the vehicle ahead. (Option, part of Pre-Collision Assist)



Cruise control with Adjustable Speed Limiter⁽²⁾

Set your desired speed and the system will maintain the pace until it's deactivated via a button on the steering wheel, or by pressing the clutch or brake pedal. Adjustable Speed Limiter is particularly helpful in towns and cities. It lets you set your chosen maximum speed and the vehicle then stays within that limit so you can keep your eyes on the road. When you need to go faster, just press the accelerator firmly to override the system. (Standard on Limited, Sport and Active, option for other series)

⁽¹⁾Uses sensors. ⁽²⁾Driver Assistance feature.

Note Driver-assist features are supplemental and do not replace the driver's attention, judgement and need to control the vehicle.

⁽¹⁾Speed limit may vary according to road and vehicle size. Driver is responsible for adhering to the speed limit at all times.

Transit Connect Van Trend L1 with Ligne in Dark Palazzo Grey/Marl and Dark Palazzo Grey/City in Ebony.



1 EXPLORE

SMART PARKING

Active Park Assist⁰²⁾ will park your Transit Connect for you. The system can locate a suitable parking space and automatically steer you into a parallel or perpendicular space. It can also manoeuvre you out of parallel spaces too. All you need to do is operate the accelerator, brake and gears. (Option)



Parking distance sensors⁰²⁾, front and rear

No need to pass by those more challenging parking spaces. An audible warning helps you judge the distance between your vehicle and obstacles at the front and rear, for easier parking and manoeuvring. (Option) (Rear parking sensors standard on Limited, Sport and Active)



Let Transit Connect park itself

Once activated, Active Park Assist⁰²⁾ can help you find a suitable parking space and will automatically steer you in – and out – as required. (Option)

⁰⁾Uses sensors. ²⁾Driver Assistance feature.

Note Driver-assist features are supplemental and do not replace the driver's attention, judgement and need to control the vehicle.

Transit Connect Van Limited L2 in Race Red solid body colour.



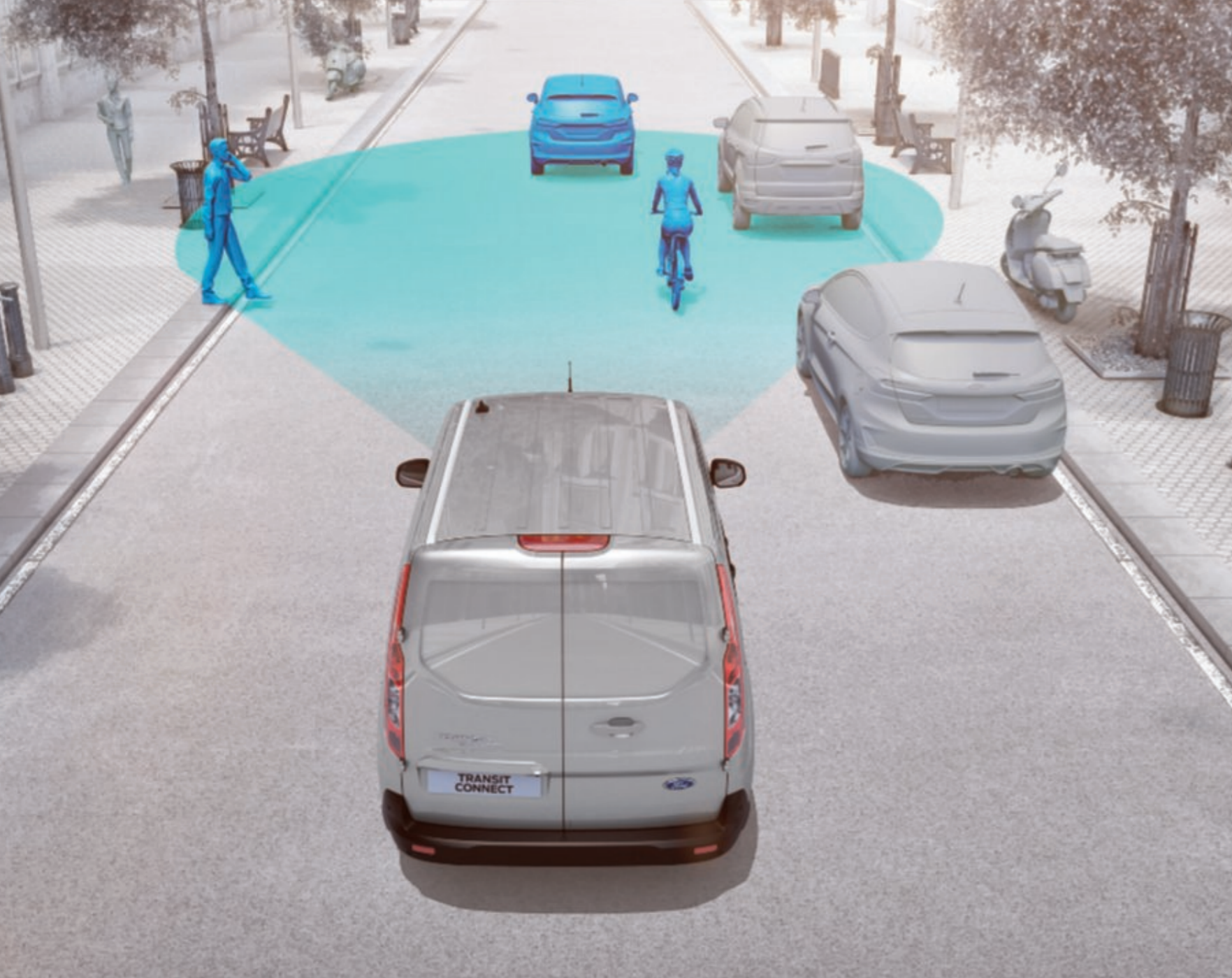

1 EXPLORE

ALWAYS PREPARED

Transit Connect is always prepared for the unexpected. Sophisticated radar scans the area ahead and alerts you to vehicles and pedestrians in your path. And a specially placed camera monitors your position on the road and can help you stay within your marked lane. Some systems are standard, while others are available as options or as part of optional packs.



Pre-Collision Assist⁽⁰²⁾ with Pedestrian and Cyclist Detection*

Monitors your proximity to other vehicles, cyclists and pedestrians. If a potential collision is detected, it can alert you with audible and visual warnings and, if needed, pre-charge the brakes and increase brake sensitivity to help provide full responsiveness when you brake. If the system determines a collision is imminent, Active Braking⁽⁰²⁾ automatically applies full braking to help mitigate the effect of any impact. (Option)



Lane-Keeping System⁽⁰²⁾ (Lane-Keeping Alert⁽⁰²⁾ and Lane-Keeping Aid⁽⁰²⁾)

Lane-Keeping Alert is designed to recognise when you approach the road markings without using the indicator and alerts you with vibrations through the steering wheel**. If you fail to react, Lane-Keeping Aid will help keep you within your marked lane**. (Option)



Side Wind Stabilisation⁽⁰¹⁾

Helps you to stay in lane in strong, gusty conditions by using the Electronic Stability Control (ESC) system to sense when the vehicle is being affected by crosswinds. (Option)

⁽⁰⁾Uses sensors. ⁽¹⁾Safety feature. ⁽²⁾Driver Assistance feature. **Note** Driver-assist features are supplemental and do not replace the driver's attention, judgement and need to control the vehicle.

*Pedestrian and Cyclist Detection is designed to operate at vehicle speeds of up to 50 mph (80 km/h). Pre-Collision Assist can detect pedestrians and cyclists, but not in all conditions and does not replace safe driving. See owner's manual for system limitations.

**Operates at speeds over 40 mph (65 km/h) on multi-lane roads with clearly visible lane markings. Lane-Keeping System does not control steering.

Transit Connect Van Limited L1 in Moondust Silver metallic body colour (option).



1 EXPLORE

HERE TO HELP

Transit Connect is here to help. Its available safety and Driver Assistance systems monitor the road and the conditions around you, helping to make your working day both easier and safer.

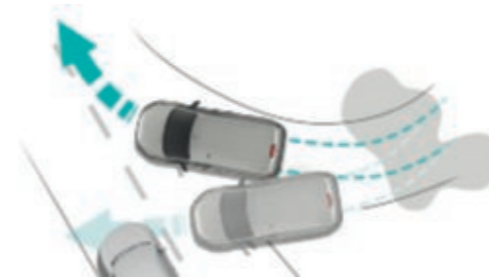

Electronic Stability Control⁽¹⁾ (ESC)

ESC is designed to help you maintain control in extreme driving conditions. It senses when you are deviating from your chosen line and aims to keep you on track by automatically regulating braking and engine output. (Standard)



Emergency Brake Assist⁽¹⁾

Designed to recognise an emergency braking situation and increases the pressure within the braking system to provide optimum stopping power. (Standard)



Load Adaptive Control⁽¹⁾

Designed to adjust the responses of the ESC system to compensate when the vehicle is unladen, partially- or fully-laden. (Standard)

⁽¹⁾Uses sensors. ⁽²⁾Safety feature.

Note Driver-assist features are supplemental and do not replace the driver's attention, judgement and need to control the vehicle.

Transit Connect Van Limited L2 in Moondust Silver metallic body colour (option).



230 V power socket

A handy 150 watt 230 V power socket, located between the driver and passenger seats, can be used to charge tools, laptops or other electrical equipment without the need for special adaptors. (Option)

Xenon headlights and LED daytime running lights

Xenon headlights offer enhanced light quality over halogen bulbs, while using less energy (option on Trend, Limited, Sport and Active). Automatic headlights⁹ switch on when outside light levels drop to illuminate the road ahead, while static cornering lights mounted in each fog light, illuminate corners during turns (standard on Limited, Sport and Active, option on Base and Trend).

⁹Uses sensors.



Ford Power starter button

Start the engine at the press of a button. Just keep the key fob with you in your pocket or bag. (Standard on Limited, Sport and Active)

Blind Spot Information System¹⁰² (includes Cross Traffic Alert)

Designed to alert you via discreet warning lights built into both door mirrors, when another vehicle – car, van or lorry – enters your blind spot. Cross Traffic Alert scans left and right as you reverse from a perpendicular parking space. If a moving vehicle or other hazard is detected, the system will alert you with visual and audible warnings. (Option on Trend, Limited, Sport and Active)

¹⁰Uses sensors. ¹¹Driver Assistance.

Note Driver-assist features are supplemental and do not replace the driver's attention, judgement and need to control the vehicle.



Automatic transmission

The 100 PS and 120 PS Ford EcoBlue diesel engines are available with an 8-speed automatic transmission, making Transit Connect even easier and more relaxing to drive. (Option)

Driver Alert¹¹

Designed to warn you if the system detects driving behaviour that indicates a drop in alertness levels. Initially, a warning icon is displayed in the instrument cluster, followed by an audible chime if driving alertness further declines. (Option as part of a pack)

¹¹Uses sensors. ¹²Safety feature.



2

SELECT

TRANSIT CONNECT

SELECT THE VEHICLE THAT'S RIGHT FOR YOU

Tailor your Transit Connect to be as individual as your business. Available with a choice of bodystyles, two wheelbase lengths and a range of distinctively different series design options, there's a Transit Connect that's right for you.

RANGE OVERVIEW



FORD TRANSIT CONNECT VAN



FORD TRANSIT CONNECT DOUBLE CAB-IN-VAN

Leader

Key exterior features

- 16" steel wheels
- Kerbside load door (Van only)
- Dual side load doors (Double Cab-in-Van only)
- Remote central locking
- Ford Easy Fuel capless refuelling system
- Spare wheel

Key interior features

- DAB radio with MP3 capability, Bluetooth® and USB

connectivity, steering wheel remote audio controls and four speakers

- Electrically-operated front windows with one-shot down on driver's side
- Rake- and reach-adjustable steering column
- DIN-compliant cargo tie-down hooks
- Overhead stowage

Bodystyles

- Van
- Double Cab-in-Van

Engines

- 1.0L Ford EcoBoost petrol 100 PS (74 kW)
- 1.5L TDCi Ford EcoBlue diesel 75 PS (55 kW)
- 1.5L TDCi Ford EcoBlue diesel 100 PS (74 kW)
- 1.5L TDCi Ford EcoBlue diesel 120 PS (88 kW)

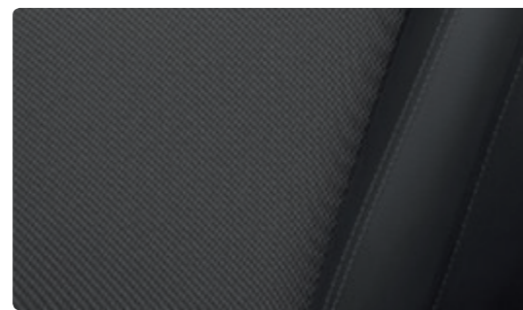

Note The Bluetooth® word mark and logos are owned by the Bluetooth SIG, Inc. and any use of such marks by Ford Motor Company Limited and its associated companies is under licence. Other trademarks and trade names are those of their respective owners.

Trend

Key exterior features in addition to Base

- 16" steel Sparkle Silver wheels with full wheel covers
- Body colour front bumper
- Body colour rear bumper end caps
- Front fog lights
- Electrically-operated and heated door mirrors
- Quickclear heated windscreen

Key interior features in addition to Base

- DAB radio with 4.2" TFT display, including message

centre, Emergency Assist*, four speakers, AUX and MP3 capability, Bluetooth® and Voice Control and audible text messaging, USB and Privacy mode

- Height adjustable driver's seat
- Front interior light with two map-reading lights
- Plastic easy-clean cargo floor liner (Van only)

Bodystyles

- Van
- Double Cab-in-Van

Engines

- 1.0L Ford EcoBoost petrol 100 PS (74 kW)
- 1.5L TDCi Ford EcoBlue diesel 75 PS (55 kW)
- 1.5L TDCi Ford EcoBlue diesel 100 PS (74 kW)
- 1.5L TDCi Ford EcoBlue diesel 120 PS (88 kW)



Note The Bluetooth® word mark and logos are owned by the Bluetooth SIG, Inc. and any use of such marks by Ford Motor Company Limited and its associated companies is under licence. Other trademarks and trade names are those of their respective owners.

*Ford Emergency Assistance uses a Bluetooth®-paired and connected mobile phone to help vehicle occupants initiate a direct call to the local Communications Centre, following a vehicle crash event involving an airbag deployment or fuel pump shut off. The feature operates in more than 40 European countries and regions.

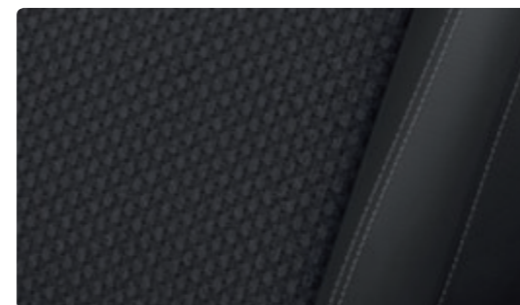

Limited

Key exterior features in addition to Trend

- 16" 5x2-spoke alloy wheels with Sparkle Silver finish
- Body colour bodyside mouldings, door handles and door mirrors
- Automatic head lights and rain-sensing wipers
- Front fog lights with static cornering
- Electrically-operated, heated and auto-fold on lock door mirrors
- Rear parking distance sensors

Key interior features in addition to Trend

- Manual air conditioning
- Cruise control with Adjustable Speed Limiter
- Heated front seats
- 4-spoke leather-trimmed multifunction steering wheel
- Ford Power starter button
- Door handles with chrome-finish

Bodystyle

- Van

Engines

- 1.5L TDCi Ford EcoBlue diesel 120 PS (88 kW)



Sport

Key exterior features in addition to Limited

- 17" 5x2-spoke machined alloy wheels with Absolute Black finish
- Sports styling kit containing front, rear and side sport stripes, aluminium roof rails, front and rear lower spoiler and chromed rear bumper moulding
- Body colour rear bumper

Key interior features in addition to Limited

- Partial leather seat trim with red stitching

Bodystyle

- Van

Engine

- 1.5L TDCi Ford EcoBlue diesel 120 PS (88 kW)

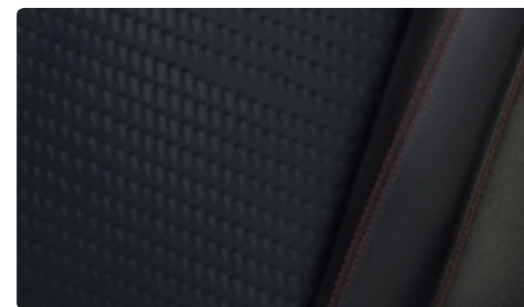

Active

Key exterior features in addition to Limited

- 17" 5-spoke machined Active alloy wheels with Absolute Black finish
- Increased ride height – 24 mm front, 9 mm rear
- Carbon Black Active front grille
- Self colour bodyside mouldings, wheel arches and door mirrors

Key interior features in addition to Limited

- Unique Active trim with Nordic Blue stitching

- Active front door scuff plates
- SYNC 3 radio with DAB, 6" TFT touchscreen display, diversity antenna, four front speakers, MP3 capability, Voice Control, Apple CarPlay, Android Auto, Emergency Assistance*, hands-free calling, GPS, Bluetooth® and audible text messaging and 2 USB

Bodystyle

- Van

Engines

- 1.5L TDCI Ford EcoBlue diesel 120 PS (88 kW)

Note The Bluetooth® word mark and logos are owned by the Bluetooth SIG, Inc. and any use of such marks by Ford Motor Company Limited and its associated companies is under licence. Other trademarks and trade names are those of their respective owners.

*Ford Emergency Assistance uses a Bluetooth®-paired and connected mobile phone to help vehicle occupants initiate a direct call to the local Communications Centre, following a vehicle crash event involving an airbag deployment or fuel pump shut off. The feature operates in more than 40 European countries and regions.



3

CUSTOMISE

Choose your colour, wheels, options and extras, and make Transit Connect unmistakably yours.



LIFE IN GLORIOUS COLOUR

Ford Transit Connect owes its beautiful and durable exterior to a special multi-stage painting process. From the wax-injected steel body sections to the protective top coat, new materials and application processes ensure your Transit Connect will retain its good looks for many years to come.

Sedona Orange
*Metallic body colour**

BODY COLOURS



Frozen White
Solid body colour



Blazer Blue
Solid body colour



Race Red
Solid body colour



Magnetic
*Metallic body colour**



Moondust Silver
*Metallic body colour**



Agate Black
*Metallic body colour**



Chrome Blue
*Metallic body colour**



Solar Silver
*Metallic body colour**

12-year perforation warranty

The Ford Transit Connect is covered by the Ford Perforation Warranty for 12 years from the date of first registration. Subject to terms and conditions.

*Metallic body colours are options, at extra cost.
Note The images used are to illustrate body colours only and may not reflect the vehicle described. Colours and trims reproduced within this brochure may vary from the actual colours, due to the limitations of the printing processes used.

Zinc coating | Phosphate coat | Electrocoat | Primer | Top coat | Clearcoat



3 CUSTOMISE TRIMS



Racer in Ebony with City in Ebony
Standard on Base



Crosshatch in Dark Palazzo Grey with Salerno Vinyl in Ebony
Option on Base



Capitol in Ebony with City in Ebony
Standard on Trend



Ligne in Dark Palazzo Grey with Marl in Dark Palazzo Grey and City in Ebony
Standard on Limited



Dynamo in Ebony with Salerno Leather in Ebony
Standard on Sport



Nunatak in Combo with Eton in Combo/Eton in Ebony with Nordic Blue Stitching
Standard on Active



3 CUSTOMISE ACCESSORIES



1.



2.



3.



4.



5.



6.

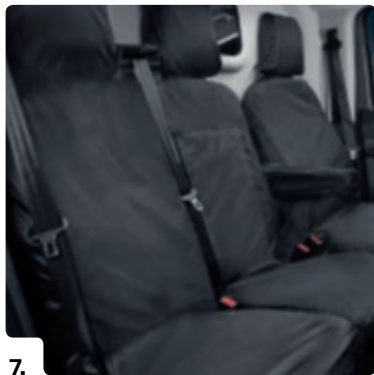

7.



8.



9.

1. 17" alloy wheels
2. Locking wheel nuts kit
3. Bosch® reverse warning device
4. Rear window protection grille*
5. Q-Top® (Q-Tech)* roof gallery
6. ClimAir® wind deflectors
7. HDD* seat cover
8. Rati* armrest
9. All-weather floor mats
10. Roof base carrier*
11. Thule® ladder holder
12. Rear ladder
13. Fixed tow bar*
14. Mudflaps*

*Item covered by third party supplier's warranty, please see back cover for details.

*Option and accessory.



SPECIAL VEHICLE OPTIONS

Ford Commercial Vehicles are designed, tested and built to work hard for you and your business. With a range of Ford Special Vehicle Options fitted at the factory, your vehicle will be better suited to your working conditions and requirements, and make conversion easier. For more details about Special Vehicle Options, please speak to your local Ford Dealer.



Special Paint Options

Your brand reflects your business, so Transit Connect is available in an extended range of colour options to help you create an even more eye-catching van with added road presence. (Option)

Note A minimum order of 14 vehicles applies or a surcharge will be added.



Glazed Rear Tailgate

Tailor your new Transit Connect Double Cab-in-Van to suit the needs of your business. The Glazed Rear Tailgate offers better vision to the rear for easier manoeuvring.

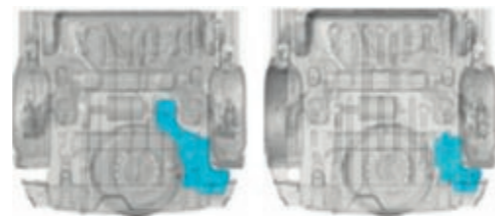

Upfitter Preparation Pack (AdBlue® tank)

This pack is designed for wheelchair accessible vehicle (WAV) conversions where the rear floor is modified, and includes a new 9-litre AdBlue® tank, associated bracketry and calibration. The alternative tank's position means that converters can install ramps to enable wheelchair access. (Option)



Sortimo® Van Racking Pack

Premium off-the-shelf van racking solution that offers maximum efficiency for your day-to-day working. This lightweight modular pack includes a non-slip phenolic floor, shelves with retainable boxes, and end panels for use with a full range of additional equipment. Easily removed/transferable to another vehicle. Crash-tested to meet current European legislation. (Option) (Image is for illustrative purposes only. Transit Connect model not shown)

4 THE POWER TO SUPPORT YOUR BUSINESS

CHOOSE THE ENGINE THAT'S RIGHT FOR YOU

Powered by our latest generation of Ford EcoBoost petrol and Ford EcoBlue diesel engines, Transit Connect is designed to work as hard as you do. Combining power, durability and efficiency, it's the ideal partner for your business. What's more, all versions comfortably meet the latest Euro Stage 6.2 emissions regulations, with CO₂ emissions from just 108 g/km. For further fuel economy and emissions information, please refer to the specifications section.

1.0L Ford EcoBoost petrol

With turbocharging, direct petrol injection, and a clever cylinder deactivation system that enables the engine to run on just two cylinders at low loads, the multiple award-winning Ford EcoBoost engine delivers the same performance as a larger unit, but with much better fuel economy and lower emissions*.

1.5L Ford EcoBlue diesel

Transit Connect is available with a choice of advanced, high-performance Ford EcoBlue diesel engines, according to series. Available with 75 PS (55 kW), 100 PS (74 kW) or 120 PS (88 kW), all versions combine plenty of pulling power for shifting heavy loads, with low running costs*.

GREATER PERFORMANCE, FEWER EMISSIONS

Transit Connect's Ford EcoBlue diesel engines comply with stringent Euro 6d EVAP-ISC-FCM emissions standards. A Selective Catalytic Reduction (SCR) system uses AdBlue®, a urea/water-based fluid to convert NO_x emissions in the exhaust gas into nitrogen and water, while the diesel particulate filter is designed to capture 99% of emitted solid particulates from the vehicle's exhaust*.

*For further fuel economy and emissions information, please refer to the specifications section.

INTERNATIONAL
engine
+
POWERTRAIN
of the year awards 2019
Presented by engine + powertrain technology international magazine

Sub 150 PS

ukimediaevents.com/engineoftheyear

170 Nm

100 PS

From
129 g/km**

EFFICIENT

1.0L Ford EcoBoost petrol

Our latest multiple award-winning 100 PS (74 kW) Ford EcoBoost petrol engine delivers an outstanding blend of efficiency and performance. Compact, lightweight and refined, it is ideally suited to shorter journeys and city driving.

**Calculated Drive Cycle test figures.

270 Nm

120 PS

From
109 g/km**

POWERFUL

1.5L Ford EcoBlue diesel

As the most powerful engine in the range, the 120 PS (88 kW) Ford EcoBlue diesel develops 270 Nm of torque. This makes it the ideal choice for carrying heavier loads and towing, yet delivers fuel efficiency from as low as 4.1 L/100 km** combined.

**Calculated Drive Cycle test figures.



4

SPECIFICATIONS

Get to know your new Ford Transit Connect inside and out, from its efficient engine technology to its generous equipment levels.

4 SPECIFICATIONS DIMENSIONS

Dimensions (mm)

	Transit Connect L1	Transit Connect L2	Transit Connect DGV (Crew Van) L1	Transit Connect (Crew Van) L2
A Overall length	4425	4825	4425	4825
B Overall width (mirrors folded)	1967	1967	1967	1967
B Overall width (mirrors unfolded)	2137	2137	2137	2137
C Overall height (unladen)	1830	1828	1819	1820
D Front overhang	885	885	885	885
E Wheelbase	2662	3062	2662	3062
F Rear overhang	878	878	878	878
G Side door entry width	612	839	612	839
G Side door entry width (Van with bulkhead)	433	660	-	-
H Rear door opening width below belt	1248	1248	1248	1248
I Loadspace width between wheel arches	1249	1249	1193	1193
J Rear door opening height (at vehicle centerline)	1202	1156	1150	1154
K Loadspace width at floor	1543	1496	1533	1533
L Side door opening height	1228	1228	1228	1228
M Loadspace floor to roof	1269	1269	1237	1267
N Loadspace length maximum to bulkhead	1786	2152	1394	2164
O¹ Loadspace length (with bulkhead, laden to belt line)	1558	1958	-	-
O² Loadspace length (back of front seat, at floor)	1831	2231	-	-
O³ Loadspace length (max, with load through bulkhead)	3000	3400	-	-
P Loading height (unladen)	599	599	593	586
Q Front track	1568	1568	1568	1568
R Rear track	1582	1582	1582	1582
S Ground clearance (unladen)	148	149	144	144

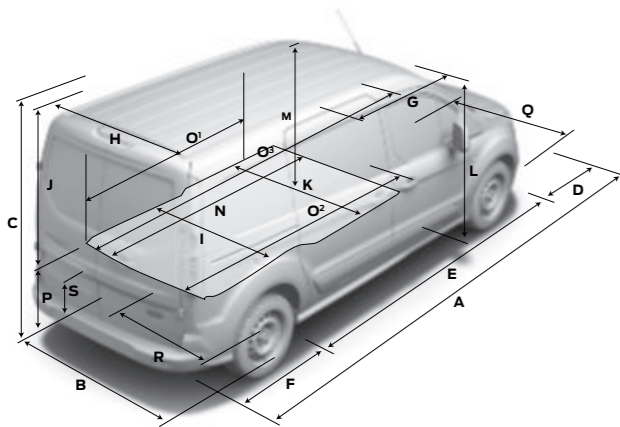

Dimensions (mm)

	Transit Connect L1	Transit Connect L2	Transit Connect DGV (Crew Van) L1	Transit Connect (Crew Van) L2
Capacity				
Cargo volume behind bulkhead (VDA/SAE)	2.6/2.9 cu.m	3.2/3.6 cu.m	- / 1.2 cu.m	- / 1.6 cu.m
Cargo volume less bulkhead (SAE)	3.0 cu.m	3.7 cu.m	-	-
Cargo volume less bulkhead, with front seat folded (SAE)	3.7 cu.m	4.4 cu.m	-	-
Turning circle (m)				
Kerb to kerb	11.0	12.2	11.0	12.2
Wall to wall	11.7	12.5	11.7	12.5
Additional information				
Interior – Front				
Effective headroom	1190	1190	1190	1190
Maximum effective leg room	1027	1027	1074	1074
Shoulder room	1464	1464	1464	1464
Hip room	1376	1376	1376	1376

L1 = Short wheelbase, **L2** = Long wheelbase. All dimensions shown in mm are subject to manufacturing tolerances and refer to minimum specification models and do not include additional equipment. These illustrations are for guidance only. Dimensions may vary dependent on the model and equipment fitted.

Want to see the full specifications?

To view the full features and specifications of this vehicle, download the digital ebrochure or view the interactive brochure at www.ford.co.uk or scan the code.



Fuel and emissions

	Fuel	Transmission	CO ₂ emissions WLTP Overall	Fuel consumption in MPG (L/100 km) ⁰⁰⁰	
				WLTP LOW	WLTP HIGH
200 L1 Transit Connect					
1.0L Ford EcoBoost 100 PS (74 kW)	Petrol	6-speed manual	158	7.8	6.1
1.5L TDCi Ford EcoBlue 75 PS (55 kW)	Diesel	6-speed manual	133-134	5.2-5.3	4.4-4.5
1.5L TDCi Ford EcoBlue 100 PS (74 kW)	Diesel	6-speed manual	135-138	5.3-5.4	4.5-4.6
1.5L TDCi Ford EcoBlue 100 PS (74 kW)	Diesel	8-speed automatic	150-153	6.3-6.4	4.9-5.0
1.5L TDCi Ford EcoBlue 120 PS (88 kW)	Diesel	6-speed manual	134-137	5.3-5.4	4.5-4.6
1.5L TDCi Ford EcoBlue 120 PS (88 kW) (with Standard Auto-Start-Stop)	Diesel	8-speed automatic	150-153	6.3-6.4	4.9-5.0
220 L1 Transit Connect High Payload					
1.5L TDCi Ford EcoBlue 75 PS (55 kW)	Diesel	6-speed manual	134	5.3	4.5
1.5L TDCi Ford EcoBlue 100 PS (74 kW)	Diesel	6-speed manual	135	5.3-5.4	4.5
1.5L TDCi Ford EcoBlue 100 PS (74 kW)	Diesel	8-speed automatic	150	6.3	4.9
1.5L TDCi Ford EcoBlue 120 PS (88 kW)	Diesel	6-speed manual	134	5.3	4.5
1.5L TDCi Ford EcoBlue 120 PS (88 kW)	Diesel	8-speed automatic	150	6.3	4.9
220 L1 Transit Connect Crew Van (DCiV)					
1.0L Ford EcoBoost 100 PS (74 kW)	Petrol	6-speed manual	163	8.0	6.3
1.5L TDCi Ford EcoBlue 75 PS (55 kW)	Diesel	6-speed manual	142	5.7	4.7
1.5L TDCi Ford EcoBlue 100 PS (74 kW)	Diesel	6-speed manual	141	5.7	4.7
1.5L TDCi Ford EcoBlue 120 PS (88 kW)	Diesel	8-speed automatic	157	6.8	5.2

Fuel and emissions

	Fuel	Transmission	CO ₂ emissions WLTP Overall	Fuel consumption in MPG (L/100 km) ⁰⁰⁰	
				WLTP LOW	WLTP HIGH
210 L2 Transit Connect					
1.0L Ford EcoBoost 100 PS (74 kW)	Petrol	6-speed manual	162	7.8-7.9	6.2
1.5L TDCi Ford EcoBlue 75 PS (55 kW)	Diesel	6-speed manual	135-137	5.3-5.4	4.5-4.6
1.5L TDCi Ford EcoBlue 100 PS (74 kW)	Diesel	6-speed manual	137-140	5.4-5.6	4.6-4.7
1.5L TDCi Ford EcoBlue 120 PS (88 kW)	Diesel	6-speed manual	137-140	5.4-5.5	4.6-4.7
1.5L TDCi Ford EcoBlue 120 PS (88 kW)	Diesel	8-speed automatic	152-156	6.4-6.5	5.0-5.1
240 L2 Transit Connect High Payload					
1.5L TDCi Ford EcoBlue 100 PS (74 kW)	Diesel	6-speed manual	137-138	5.4-5.5	4.6
1.5L TDCi Ford EcoBlue 120 PS (88 kW)	Diesel	6-speed manual	137	5.4-5.5	4.6
1.5L TDCi Ford EcoBlue 120 PS (88 kW)	Diesel	8-speed automatic	152-153	6.4-6.5	5.0
230 L2 Transit Connect Crew Van (DCiV)					
1.5L TDCi Ford EcoBlue 100 PS (74 kW)	Diesel	6-speed manual	144-146	5.8-6.0	4.8-4.9
1.5L TDCi Ford EcoBlue 120 PS (88 kW)	Diesel	6-speed manual	146	6.0	4.9
1.5L TDCi Ford EcoBlue 120 PS (88 kW)	Diesel	8-speed automatic	157	6.8	5.2

L1 = Short wheelbase, **L2** = Long wheelbase. **Note:** All diesel engines include coated diesel particulate filter (cDPF). ***Kerb mass** = The weight of the complete vehicle and all equipment including 90% fuel and water, but without the payload, driver or any passengers. **GVM** = Gross vehicle mass, the total permissible all-up weight of a vehicle – i.e. with body, payload, ancillaries, fuel, oil, water, driver and passengers. **GTM** = Gross train mass, the total permissible all-up weight of a vehicle (see GVM) together with its trailer and load. ***Gross Payload** = Gross vehicle mass less kerb mass. All kerb masses quoted in this brochure are for Base models with minimum equipment. Trend, Limited and Sport models will have greater kerb masses and therefore lower payloads, due to the increased amount of standard equipment. Any additional options specified on the vehicle will reduce the payload accordingly. It must be noted that actual weight will always be subject to manufacturing tolerances which may result in payload variations between this table of figures and actual weight. NB: It is the responsibility of the vehicle operator to ensure their vehicles are legally compliant for road use.

⁰⁰⁰The declared fuel/energy consumptions, CO₂-emissions and electric ranges are determined according to the technical requirements and specifications of the European Regulations (EC) 715/2007 and (EU) 2017/1151 as last amended. Light Duty vehicles type-approved using the Worldwide Harmonised Light Vehicle Test Procedure (WLTP) will have fuel/energy consumptions and CO₂-emission information for New European Drive Cycle (NEDC) and WLTP. WLTP will fully replace the NEDC latest by end of the year 2020. The applied standard test procedures enable comparison between different vehicle types and different manufacturers. In addition to the fuel efficiency of a vehicle, driving behaviour as well as other non-technical factors play a role in determining a vehicle's fuel/energy consumption, CO₂ emissions and electric ranges. CO₂ is the main greenhouse gas responsible for global warming. A guide on fuel economy and CO₂ emissions which contains data for all new passenger carrying vehicle models is available at any point of sale free of charge or can be downloaded under <https://www.ford.co.uk/owner/resources-and-support/fuel-economy>. For further information see (EU) 2017/1151.

⁰⁰⁰The declared fuel/energy consumptions and CO₂ emissions for Stage 6c (NI) and Stage 6d-TEMP (MI) engines are measured according to the technical requirements and specifications of European Regulations (EC) 715/2007, (EC) 692/2008 and (EU) 2017/1151, as last amended. Fuel consumption and CO₂ emissions may be specified for a vehicle variant and not for a single vehicle. The applied standard test procedure enables a comparison between different vehicle types and different manufacturers. In addition to the fuel efficiency of a vehicle; driving behaviour as well as other non-technical factors are very important in determining a vehicle's fuel/energy consumption and CO₂ emissions. A guide on fuel economy and CO₂ emissions which contains data for all new passenger carrying vehicle models is available at any point of sale free of charge or can be downloaded under <https://www.ford.co.uk/owner/resources-and-support/fuel-economy>. For further information see (EU) 2017/1151.

GET THE MOST FROM YOUR NEW FORD

We want to help you get the most from your new Ford. And to do that, you need to know how much it is designed to safely carry, both in terms of payload and load volume. Your Transit Centre can provide professional advice on important specification aspects, and help to find the right van for your budget and business needs.

The Ford Transit Connect is designed to carry cargo – and lots of it.

Choosing a new van is an important decision with lots of factors to be considered. While some aspects, like selecting the most appropriate derivative, identifying the intended primary use and determining load box size are relatively simple, others, such as calculating payload are more complex.

Payload capacity

To calculate payload, you need to know two things: the vehicle's gross vehicle mass (GVM) and its kerb mass.

GVM is the maximum permissible weight of the vehicle when loaded and ready to go – that includes the weight of the vehicle itself, ancillaries, driver and crew (assuming the industry standard weight of 75 kg/person), fluids, fuel tank 90% full (1 litre of diesel = approximately 0.85 kg), optional and aftermarket equipment, and cargo.

For simplicity, Ford Transit models are designated according to their GVM. For example, a 280 has a GVM of c. 2,800 kg; and a 300 has a GVM of c. 3,000 kg.

Kerb mass is the weight of a standard-specification Base series vehicle, including fluids and fuel tank 90% full, but without the driver, crew or cargo.

Payload is the difference between the two.

Gross vehicle mass minus **kerb mass** = **payload**

So to help you choose the right vehicle for your needs, here are some more detailed explanations about the factors that can influence a vehicle's payload. These include, but are not limited to:

Driver and crew

We calculate the weight of the driver and crew based on the industry-standard weight of 75 kg/person. Remember that the driver and crew are not included in the kerb mass figure, so when a driver or crew boards the vehicle, its payload will be reduced accordingly.

Factory-fitted options

Most factory-fitted options will affect a vehicle's payload. For example, air conditioning can add approximately 18 kg to a vehicle's weight, and therefore reduce its payload accordingly.

However, specifying a single front passenger seat in lieu of the standard dual seat will reduce the vehicle's weight by approximately 12 kg, and increase its payload by the same amount. Your Transit Centre will be able to tell you what features can add or reduce your vehicle's kerb mass and by how much.

Series

All kerb masses quoted in this brochure are for standard-specification Base series models, unless otherwise stated. Trend, Limited, Active and Sport series models will generally weigh more than Base series due to the increased level of features and equipment.

Manufacturing tolerances

Variations in manufacturing and production processes mean that no two vehicles are likely to weigh exactly the same.

Accessories and aftermarket conversions

It is important to think carefully about what you add to your vehicle after you take delivery. Any accessories fitted or aftermarket conversions to the vehicle may adversely affect its payload. Please speak to your Transit Centre for more information and advice.

If payload is critical to your business, or if you plan to carry cargo at, or close to, the vehicle's maximum capacity, your Transit Centre can help. Using their specialist expertise and knowledge, they can advise you on the exact specification of vehicle required to meet your individual business needs.

Configure your van to suit your job

Ford Commercial Vehicles are available with a wide range of standard and optional features. Your Transit Centre can help you ensure that you specify the right vehicle features for your specific business needs, including technical items to aid aftermarket fitment of specialist equipment or conversion.

Note Technical information for vehicle converters can be found online via the Body and Equipment Mounting Manual @etis.ford.com go to >information >>vehicle conversions.

Weights and loads

	Fuel	Transmission	Gross payload (kg) ⁹	Gross vehicle mass (kg)	Kerb mass – excluding driver (kg) ^{10*}	Max. GTM (kg) with quoted axle ratio	Trailer plate (kg) Braked (unbraked)
200 L1 Transit Connect							
1.0L Ford EcoBoost 100 PS (74 kW)	Petrol	6-speed manual	679-892	2030-2305	1535-1537	3250	1200 (735-750)
1.5L TDCi Ford EcoBlue 75 PS (55 kW)	Diesel	6-speed manual	684-688	2155-2175	1830-1835	3350	1200 (750)
1.5L TDCi Ford EcoBlue 100 PS (74 kW)	Diesel	6-speed manual	684-978	2160-2501	1647-1834	3500	1350 (750)
1.5L TDCi Ford EcoBlue 100 PS (74 kW)	Diesel	8-speed automatic	690-659	2180-2501	1667-1854	3500	1350 (750)
1.5L TDCi Ford EcoBlue 120 PS (88 kW)	Diesel	6-speed manual	688-982	2155-2501	1589-1830	3590	1470-1500 (750)
1.5L TDCi Ford EcoBlue 120 PS (88 kW)	Diesel	8-speed automatic	690-959	2405-2180	1612-1854	3540	1470-1500 (750)
220 L1 Transit Connect High Payload							
1.5L TDCi Ford EcoBlue 75 PS (55 kW)	Diesel	6-speed manual	698-892	2150-2370	1521-1841	3350	1200 (750)
1.5L TDCi Ford EcoBlue 100 PS (74 kW)	Diesel	6-speed manual	898-887	2375-2380	1836-1841	3500	1350 (750)
1.5L TDCi Ford EcoBlue 100 PS (74 kW)	Diesel	8-speed automatic	893-909	2405	1856-1860	3500	1350 (750)
1.5L TDCi Ford EcoBlue 120 PS (88 kW)	Diesel	6-speed manual	897	2370-2385	1832-1836	3590	1500 (750)
1.5L TDCi Ford EcoBlue 120 PS (88 kW)	Diesel	8-speed automatic	893-909	2405	1856-1860	3540	1500 (750)
220 L1 Transit Connect Crew Van (DCiV)							
1.0L Ford EcoBoost 100 PS (74 kW)	Petrol	6-speed manual	745-788	2255-2305	1600-1620	3250	1200 (750)
1.5L TDCi Ford EcoBlue 100 PS (74 kW)	Diesel	6-speed manual	777-778	2375-2380	1697-1702	3500	1350 (750)
1.5L TDCi Ford EcoBlue 120 PS (88 kW)	Diesel	6-speed manual	777	2375	1701	3590	1500 (750)
1.5L TDCi Ford EcoBlue 120 PS (88 kW)	Diesel	8-speed automatic	742-768	2360-2375	1708-1712	3540	1500 (750)

L1 = Short wheelbase, **L2** = Long wheelbase. **Note:** All diesel engines include coated diesel particulate filter (cDPF). ***Kerb mass** = The weight of the complete vehicle and all equipment including 90% fuel and water, but without the payload, driver or any passengers. **GVM** = Gross vehicle mass, the total permissible all-up weight of a vehicle – i.e. with body, payload, ancillaries, fuel, oil, water, driver and passengers. **GTM** = Gross train mass, the total permissible all-up weight of a vehicle (see GVM) together with its trailer and load. **Gross Payload** = Gross vehicle mass less kerb mass. All kerb masses quoted in this brochure are for Base models with minimum equipment. Trend, Limited and Sport models will have greater kerb masses and therefore lower payloads, due to the increased amount of standard equipment. Any additional options specified on the vehicle will reduce the payload accordingly. It must be noted that actual weight will always be subject to manufacturing tolerances which may result in payload variations between this table of figures and actual weight. NB: It is the responsibility of the vehicle operator to ensure their vehicles are legally compliant for road use.

⁹The declared fuel/energy consumptions, CO₂-emissions and electric ranges are determined according to the technical requirements and specifications of the European Regulations (EC) 715/2007 and (EU) 2017/1151 as last amended. Light Duty vehicles type-approved using the Worldwide Harmonised Light Vehicle Test Procedure (WLTP) will have fuel/energy consumptions and CO₂-emission information for New European Drive Cycle (NEDC) and WLTP. WLTP will fully replace the NEDC latest by end of the year 2020. The applied standard test procedures enable comparison between different vehicle types and different manufacturers. In addition to the fuel efficiency of a vehicle, driving behaviour as well as other non-technical factors play a role in determining a vehicle's fuel/energy consumption, CO₂ emissions and electric ranges. CO₂ is the main greenhouse gas responsible for global warming. A guide on fuel economy and CO₂ emissions which contains data for all new passenger carrying vehicle models is available at any point of sale free of charge or can be downloaded under <https://www.ford.co.uk/owner/resources-and-support/fuel-economy>. For further information see (EU) 2017/1151.

¹⁰The declared fuel/energy consumptions and CO₂ emissions for Stage 6c (NI) and Stage 6d-TEMP (MI) engines are measured according to the technical requirements and specifications of European Regulations (EC) 715/2007, (EC) 692/2008 and (EU) 2017/1151, as last amended. Fuel consumption and CO₂ emissions may be specified for a vehicle variant and not for a single vehicle. The applied standard test procedure enables a comparison between different vehicle types and different manufacturers. In addition to the fuel efficiency of a vehicle; driving behaviour as well as other non-technical factors are very important in determining a vehicle's fuel/energy consumption and CO₂ emissions. A guide on fuel economy and CO₂ emissions which contains data for all new passenger carrying vehicle models is available at any point of sale free of charge or can be downloaded under <https://www.ford.co.uk/owner/resources-and-support/fuel-economy>. For further information see (EU) 2017/1151.

Weights and loads

	Fuel	Transmission	Gross payload (kg) ^o	Gross vehicle mass (kg)	Kerb mass – excluding driver (kg) [★]	Max. GTM (kg) with quoted axle ratio	Trailer plate (kg) Braked (unbraked)
210 L2 Transit Connect							
1.0L Ford EcoBoost 100 PS (74 kW)	Petrol	6-speed manual	715-850	2168-2325	1599-1635	3250	1200 (750)
1.5L TDCi Ford EcoBlue 100 PS (74 kW)	Diesel	6-speed manual	712-850	2165-2325	1599-1635	3250	1200 (750)
1.5L TDCi Ford EcoBlue 120 PS (88 kW)	Diesel	6-speed manual	720-946	2255-2501	1679-1903	3590	1470-1500 (750)
1.5L TDCi Ford EcoBlue 120 PS (88 kW)	Diesel	8-speed automatic	731-935	2275-2501	1689-1913	3540	1470 (750)
240 L2 Transit Connect High Payload							
1.5L TDCi Ford EcoBlue 100 PS (74 kW)	Diesel	6-speed manual	839-961	2405-2501	1688-1909	3500	1350 (750)
1.5L TDCi Ford EcoBlue 120 PS (88 kW)	Diesel	6-speed manual	839-961	2405-2501	1689-1909	3590	1470-1500 (750)
1.5L TDCi Ford EcoBlue 120 PS (88 kW)	Diesel	8-speed automatic	803-955	2380-2501	1700-19158	3540	1475-1500 (750)
230 L2 Transit Connect Crew Van (DCiV)							
1.5L TDCi Ford EcoBlue 100 PS (74 kW)	Diesel	6-speed manual	745-746	2400-2405	1752-1758	3500	1350 (750)
1.5L TDCi Ford EcoBlue 120 PS (88 kW)	Diesel	6-speed manual	748	2405	1756	3590	1500 (750)
1.5L TDCi Ford EcoBlue 120 PS (88 kW)	Diesel	8-speed automatic	768-776	2430-2445	1755-1760	3540	1490-1500 (750)

L1 = Short wheelbase, **L2** = Long wheelbase. **Note:** All diesel engines include coated diesel particulate filter (cDPF). **★Kerb mass** = The weight of the complete vehicle and all equipment including 90% fuel and water, but without the payload, driver or any passengers. **GVM** = Gross vehicle mass, the total permissible all-up weight of a vehicle – i.e. with body, payload, ancillaries, fuel, oil, water, driver and passengers. **GTM** = Gross train mass, the total permissible all-up weight of a vehicle (see GVM) together with its trailer and load. **oGross Payload** = Gross vehicle mass less kerb mass. All kerb masses quoted in this brochure are for Base models with minimum equipment. Trend, Limited and Sport models will have greater kerb masses and therefore lower payloads, due to the increased amount of standard equipment. Any additional options specified on the vehicle will reduce the payload accordingly. It must be noted that actual weight will always be subject to manufacturing tolerances which may result in payload variations between this table of figures and actual weight. NB: It is the responsibility of the vehicle operator to ensure their vehicles are legally compliant for road use.

^{oo}The declared fuel/energy consumptions, CO₂-emissions and electric ranges are determined according to the technical requirements and specifications of the European Regulations (EC) 715/2007 and (EU) 2017/1151 as last amended. Light Duty vehicles type-approved using the Worldwide Harmonised Light Vehicle Test Procedure (WLTP) will have fuel/energy consumptions and CO₂-emission information for New European Drive Cycle (NEDC) and WLTP. WLTP will fully replace the NEDC latest by end of the year 2020. The applied standard test procedures enable comparison between different vehicle types and different manufacturers. In addition to the fuel efficiency of a vehicle, driving behaviour as well as other non-technical factors play a role in determining a vehicle's fuel/energy consumption, CO₂ emissions and electric ranges. CO₂ is the main greenhouse gas responsible for global warming. A guide on fuel economy and CO₂ emissions which contains data for all new passenger carrying vehicle models is available at any point of sale free of charge or can be downloaded under <https://www.ford.co.uk/owner/resources-and-support/fuel-economy>. For further information see (EU) 2017/1151.

^{oo}The declared fuel/energy consumptions and CO₂ emissions for Stage 6c (NI) and Stage 6d-TEMP (MI) engines are measured according to the technical requirements and specifications of European Regulations (EC) 715/2007, (EC) 692/2008 and (EU) 2017/1151, as last amended. Fuel consumption and CO₂ emissions may be specified for a vehicle variant and not for a single vehicle. The applied standard test procedure enables a comparison between different vehicle types and different manufacturers. In addition to the fuel efficiency of a vehicle; driving behaviour as well as other non-technical factors are very important in determining a vehicle's fuel/energy consumption and CO₂ emissions. A guide on fuel economy and CO₂ emissions which contains data for all new passenger carrying vehicle models is available at any point of sale free of charge or can be downloaded under <https://www.ford.co.uk/owner/resources-and-support/fuel-economy>. For further information see (EU) 2017/1151.

Engine data

	Transmission	Engine technical features	Maximum power ^o	Maximum torque ^o
1.0L Ford EcoBoost 100 PS (74 kW) Petrol Emissions standard Euro 6d TEMP-EVAP-ISC	6-speed manual	3 cylinders in line, DOHC, 12 valves, alloy cylinder head, direct injection with high pressure, common rail fuel injection system, turbocharger with intercooler	100 PS (74 kW)	170 Nm
1.5L TDCi Ford EcoBlue 75 PS (55 kW) Diesel Emissions standard Euro 6d TEMP-EVAP-ISC	6-speed manual	4 cylinders in line, DOHC, 16 valves, aluminium cylinder block with open deck, direct injection via solenoid injectors, common rail 3rd generation fuel injection system, fixed geometry turbocharger with intercooler, variable displacement oil pump, thermal override, 'split' sump, electronic actuator and controllable water cooled charge air cooler	75 PS (55 kW)	220 Nm
1.5L TDCi Ford EcoBlue 100 PS (74 kW) Diesel Emissions standard Euro 6d TEMP-EVAP-ISC	6-speed manual	4 cylinders in line, DOHC, 16 valves, aluminium cylinder block with open deck, direct injection via solenoid injectors, common rail 3rd generation fuel injection system, fixed geometry turbocharger with intercooler, variable displacement oil pump, thermal override, 'split' sump, electronic actuator and controllable water cooled charge air cooler	100 PS (74 kW)	240 Nm
1.5L TDCi Ford EcoBlue 100 PS (74 kW) Diesel Emissions standard Euro 6d TEMP-EVAP-ISC	8-speed automatic	4 cylinders in line, DOHC, 16 valves, aluminium cylinder block with open deck, direct injection via solenoid injectors, common rail 3rd generation fuel injection system, fixed geometry turbocharger with intercooler, variable displacement oil pump, thermal override, 'split' sump, electronic actuator and controllable water cooled charge air cooler	100 PS (74 kW)	240 Nm
1.5L TDCi Ford EcoBlue 120 PS (88 kW) Diesel Emissions standard Euro 6d TEMP-EVAP-ISC	6-speed manual	4 cylinders in line, DOHC, 16 valves, aluminium cylinder block with open deck, direct injection via solenoid injectors, common rail 3rd generation fuel injection system, fixed geometry turbocharger with intercooler, variable displacement oil pump, thermal override, 'split' sump, electronic actuator and controllable water cooled charge air cooler	120 PS (88 kW)	270 Nm
1.5L TDCi Ford EcoBlue 120 PS (88 kW) Diesel Emissions standard Euro 6d TEMP-EVAP-ISC	8-speed automatic	4 cylinders in line, DOHC, 16 valves, aluminium cylinder block with open deck, direct injection via solenoid injectors, common rail 3rd generation fuel injection system, fixed geometry turbocharger with intercooler, variable displacement oil pump, thermal override, 'split' sump, electronic actuator and controllable water cooled charge air cooler	120 PS (88 kW)	270 Nm

^oTested in accordance with ISO 1585. **Note:** All diesel engines are fitted with a standard cDPF (coated diesel particulate filter).

Model availability

	Transmission	L1							L2						
		Leader	Leader High Payload	Trend	Trend High Payload	Limited	Sport	Active	Leader	Leader High Payload	Trend	Trend High Payload	Limited	Sport	Active
Ford Transit Connect/High Payload Van															
1.0L Ford EcoBoost 100 PS (74 kW)	6-speed manual	●	-	●	-	-	-	-	●	-	●	-	-	-	-
1.5L TDCi Ford EcoBlue 75 PS (55 kW)	6-speed manual	●	●	●	-	-	-	-	●	-	-	-	-	-	-
1.5L TDCi Ford EcoBlue 100 PS (74 kW)	6-speed manual	●	●	●	●	-	-	-	●	●	●	●	-	-	-
1.5L TDCi Ford EcoBlue 100 PS (74 kW)	8-speed automatic	-	●	-	-	-	-	-	-	-	-	-	-	-	-
1.5L TDCi Ford EcoBlue 120 PS (88 kW)	6-speed manual	-	-	●	●	●	●	●	●	●	-	●	●	●	●
1.5L TDCi Ford EcoBlue 120 PS (88 kW)	8-speed automatic	-	-	-	●	●	●	●	-	●	-	●	●	●	●
Ford Transit Connect Crew Van (DCiV)															
1.0L Ford EcoBoost 100 PS (74 kW)	6-speed manual	●	-	●	-	-	-	-	-	-	-	-	-	-	-
1.5L TDCi Ford EcoBlue 75 PS (55 kW)	6-speed manual	-	-	-	-	-	-	-	-	-	-	-	-	-	-
1.5L TDCi Ford EcoBlue 100 PS (74 kW)	6-speed manual	●	-	●	-	-	-	-	●	-	●	-	-	-	-
1.5L TDCi Ford EcoBlue 100 PS (74 kW)	8-speed automatic	●	-	-	-	-	-	-	●	-	-	-	-	-	-
1.5L TDCi Ford EcoBlue 120 PS (88 kW)	6-speed manual	-	-	-	-	-	-	-	-	-	●	-	-	-	-
1.5L TDCi Ford EcoBlue 120 PS (88 kW)	8-speed automatic	-	-	●	-	-	-	-	-	-	●	-	-	-	-

● = Available. **Note:** all diesel engines are fitted with a standard cDPF (catalysed diesel particulate filter). **L1** = Short wheelbase, **L2** = Long wheelbase.

Styling and appearance

	L1&L2					DCiV L1&L2		
	Leader	Trend	Limited	Sport	Active	Leader	Trend	MFC Code
Wheels								
Steel wheels – 16"x 6½" painted Shadow Silver (fitted with 205/60 tyres n/a DCiV LWB Automatic)*	●	-	-	-	-	●	-	D5AAG/D2XD8
Steel wheels – 16"x 6½" painted Sparkle Silver wheel covers (fitted with 205/60 tyres (except LWB High Payload & DCiV LWB Automatic)	-	●	-	-	-	-	●/-	D2XAD/D5AA3
Alloy wheels – 16"x6½" painted Sparkle Silver (fitted with 205/60 tyres) (standard on Trend LWP HP Van * DCiV Trend series Auto)	-	●/○	●	-	-	□	●/○	D2XA1
Alloy wheels – 17"x6½" Sport painted Foundry Black with machined finish (fitted with 215/55 tyres)	-	-	-	●	-	-	-	D2YGU
Alloy wheels – 17"x6½" Active painted Foundry Black with machined finish (fitted with 215/55 tyres)	-	-	-	-	●	-	-	D2YFU
Standard tread tyres	●	●	●	●	●	●	●	D3UAB/D3WAB
All-weather tyres with 3 Peak Mountain Snow Flake rating	○	○	○	○	○	○	○	D3UAK/D3WAK
Locking wheel nuts (included with alloy wheels only)	-	□	●	●	●	-	□	D5EAD
Tyre repair kit (deletes spare wheel)	○	○	○	-	○	-	-	AHTAB/D17AA/J4IAB
Steel spare wheel	●	●	●	○	●	○	○	D17AD

● = Standard, ○ = Option, at extra cost, □ = Part of an option pack, at extra cost. **L1** = Short wheelbase, **L2** = Long wheelbase. *The wheel you choose will be fitted with the tyre size noted, but no choice of tyre brand is available.

Styling and appearance

	L1&L2		DCIV L1&L2					MFC Code
	Leader	Trend	Limited	Sport	Active	Leader	Trend	
Design features								
Sports Styling Pack – Contains front and rear sports stripes, roof rails, front and rear lower spoiler and chromed rear bumper moulding	–	–	–	●	–	–	–	ACLA4
Delete sports stripes	–	–	–	○	–	–	–	ACLA5
Front bumper – Self colour	●	–	–	–	–	●	–	CLFGB
Front bumper – Body colour	–	●	●	●	●	–	●	CLFGF
Front skid plate – silver	–	–	–	–	●	–	–	–
Front grille – Self colour	●	●	●	●	–	●	●	BLDCX
Front grille – Black Mesh	–	–	–	–	●	–	–	BLDAV
Rear bumper – Self colour	●	●	●	–	●	●	●	CLMCC
Rear bumper – Body colour	–	–	–	●	–	–	–	CLMAK
Rear bumper end caps – Self colour (included with SVO paint options on Trend – please refer to SVO table for details)	●	–	–	–	–	●	–	CLEAB
Rear bumper end caps – Body colour	–	●	●	●	●	–	●	CLEAC
Rear skid plate – silver (not available with detachable tow bar)	–	–	–	–	●	–	–	–
Rear door full width black decal with Active cut-out logo	–	–	–	–	●	–	–	–
Rear bumper moulding – Chromed	–	–	–	●	–	–	–	CL6AB
Wheel arch mouldings – Self colour	–	–	–	–	●	–	–	–
Wide bodyside moulding – Self colour	●	●	–	–	●	●	●	BMBAC
Wide bodyside moulding – Body colour	–	–	●	●	–	–	–	BMBBL
Door handles – Self colour	●	●	–	–	–	●	●	CAAAE
Door handles – Body colour	–	–	●	●	●	–	–	CAAAC
Cargo door/tailgate handle – Self colour	●	●	–	–	–	●	●	CACAF
Cargo door/tailgate handle – Body colour	–	–	●	●	●	–	–	CACAC
Mudflaps – Front	○	○	○	○	–	○	○	A3EAB
Mudflaps – Rear	○	○	○	–	–	○	○	AIKAB
Roof rails (not available on DCIV)	○	○	○	●	●	○	○	BLYA3
Roof rails, with crossbars (only available for Commercial Kombi M1 L2 on Base, DCIV L1 and Commercial Kombi L1, not available on L2 Trend)	○/-	○/-	–	–	–	○/-	○/-	BLYAB

● = Standard, ○ = Option, at extra cost, □ = Part of an option pack, at extra cost. **L1** = Short wheelbase, **L2** = Long wheelbase. *The wheel you choose will be fitted with the tyre size noted, but no choice of tyre brand is available.

Driving experience

	VAN L1 & L2					DCIV L1&L2		
	Leader	Trend	Limited	Sport	Active	Leader	Trend	MFC Code
Driver assistance								
Parking distance sensors – Rear	○/□	○/□	●	●	●	○/□	○/□	HNKAB
Parking distance sensors – Front (includes rear sensors & front fog lamps on Leader series)	○/□	○/□	○/□	○/□	○/□	○/□	○/□	HNLAB
Active Park Assist (only available with SYNC 3 in-car entertainment packs, includes front and rear parking distance sensors)	○	○	○	○	○	○	○	HNSAC
Blind Spot Information System	□	□	□	□	□	–	–	HLLAD
Rear-view camera with mirror display	○	○	○	○	–	○	○	J3KAM
Rear-view camera in touchscreen display (included with SYNC 3 in-car entertainment packs)	□	□	□	□	●	□	□	J3KAB
Cruise control with Adjustable Speed Limiter (not available for Commercial Kombi M1)	○/□	○/□	●	●	●	○/□	○/□	GTDAJ
Cruise control with Adjustable Speed Limiter and Traffic Sign Recognition	○	○	○	○	○	○	○	GTDAY
Adaptive Cruise Control with Adjustable Speed Limiter, Traffic Sign Recognition and Pre-Collision Assist with Pedestrian and Cyclist Detection and Active Braking	○	○	○	○	○	○	○	GTDAZ
Pre-Collision Assist with Active Braking and Pedestrian and Cyclist Detection (camera version)	○	○	○	○	○	○	○	FBFAB
Pre-Collision Assist with Active Braking, Pedestrian and Cyclist Detection and Lane-Keeping Aid (camera/radar fusion version) (included in Adaptive Cruise Control)	○/□	○/□	○/□	○/□	○/□	○/□	○/□	FBFAC
Lane-Keeping Aid (includes Driver Alert)	○/□	○/□	○/□	○/□	○/□	○/□	○/□	HLNAB
Traffic Sign Recognition (included with Adjustable Speed Limiter and Lane-Keeping Aid)	□	□	□	□	□	□	□	HLQAB
Trailer Sway Control (included with Towing Packs)	□	□	□	□	□	□	□	C2DAB
Speed Limiter – 56 mph/90 km/h	○	○	○	○	○	○	○	DCFAH
Speed Limiter – 62 mph/100 km/h	○	○	○	○	○	○	○	DCFAG
Speed Limiter – 70mph / 130 km/h	○	○	○	–	○	○	○	DCFAF

● = Standard, ○ = Option, at extra cost, □ = Part of an option pack, at extra cost. **L1** = Short wheelbase, **L2** = Long wheelbase. ²⁾Driver assistance.

Driving experience

	VAN L1 & L2					DCIV L1&L2			MFC Code
	Leader	Trend	Limited	Sport	Active	Leader	Trend		
Exterior lighting									
Fog lights – Front	–	●	–	–	–	–	●	JBKAB	
Fog lights – Adaptive cornering lights	○/□	○/□	●	●	●	○/□	○/□	JBKAL	
Headlights – Halogen, side lights, rear fog light, reversing light	●	●	●	●	●	●	●	JBBAB	
Headlights – Bi-xenon HID (high intensity discharge) with LED daytime running lights	–	○	○	○	○	–	○	JBBAC	
Automatic headlights	–	○	●	●	●	–	○	JEDAD	
Auto high beam headlights (includes autowipers)	○	○	○	○	○	○	○	JEDAF/CFFAE	
Headlights – Courtesy delay	–	□	●	●	●	–	□	JBIAB	
Headlights – Daytime running lights	●	●	●	●	●	●	●	JBCAB	
Suspension									
Twist-beam	●	●	●	●	●	●	●	–	
Raised ride height	–	–	–	–	●	–	–	–	
Instruments and controls									
Tyre Pressure Monitoring System (TPMS)	○	○	○	○	○	○	○	HJCAB	
Adjustable steering column – Tilting and telescopic	●	●	●	●	●	●	●	GRAAF	
Option Packs									
Lighting pack – Includes cruise control with Adjustable Speed Limiter, rear parking distance sensors, adaptive cornering fog lights and automatic headlights	–	–	–	–	–	–	○	AGJAG	

● = Standard, ○ = Option, at extra cost, □ = Part of an option pack, at extra cost. **L1** = Short wheelbase, **L2** = Long wheelbase. ²⁾Driver assistance.

Performance and efficiency

	L1					L2						MFC Code
	Base	Trend	Limited	Sport	Active	Base	Trend	Limited	Sport	Active		
Engine												
Ford Easy Fuel capless refuelling system	●	●	●	●	●	●	●	●	●	●	●	–
Fuel tank – 60 litres	●	●	●	●	●	●	●	●	●	●	●	–
AdBlue® tank – 17 litres (available only with diesel engines)	●	●	●	●	●	●	●	●	●	●	●	–
6-speed manual	●	●	●	●	●	●	●	●	●	●	●	TR-E8
8-speed automatic (engine dependent)	○	○	○	○	○	○	○	○	○	○	○	TR-GM
Technology												
Active Shutter Grille	●	●	●	●	●	●	●	●	●	●	●	BLHAB
Auto Start-Stop	●	●	●	●	●	●	●	●	●	●	●	DECAU
Manual regeneration (not available with petrol engine)	○	○	○	○	○	○	○	○	○	○	○	A6YAB
Programmable interface module (not available with petrol engine)	○	○	○	○	○	○	○	○	○	○	○	JRSAB
Manual shift EcoSelect (requires manual transmission)	●	●	●	●	●	●	●	●	●	●	●	FLNAM
Acceleration Control (Only for Van. Not available with automatic transmission or for petrol engines)	○	○	○	○	○	○	○	○	○	○	○	C7JAB
Quaife mechanical Limited Slip Differential (mLSD) (available with 120PS manual)	○	○	○	○	○	○	○	○	○	○	○	EGKAC

● = Standard, ○ = Option, at extra cost.

Comfort and convenience

	VAN L1&L2					DCiV L1			MFC Code
	Leader	Trend	Limited	Sport	Active	Leader	Trend		
Interior convenience									
Instrument panel storage box	●	●	●	●	●	●	●	●	BBMAB
Dual front cup holders	●	●	●	●	●	●	●	●	B5ZAE
Glovebox lid	-	●	●	●	●	-	●	●	B5LAC
Single passenger seat centre console	●	●	●	●	●	●	●	●	B5WCA
Dual passenger under seat console	□	□	□	□	□	-	-	-	B5WCC
Sunvisor, driver's & passengers (drivers side includes mirror, flap and ticket pocket except Leader)	-	●	●	●	●	-	●	●	BCAAZ
Audio and communication systems									
Delete ICE Pack. Pre-equipment pack (2 Speakers). ICE Pack 30	○	-	-	-	-	○	-	-	ICFA6
DAB Radio, steering wheel radio controls, four speakers, AUX, MP3 capability and Bluetooth®.ICE pack 2	●	-	-	-	-	●	-	-	ICFAC
DAB Radio with 4.2" TFT screen display, steering wheel radio controls, four front speakers, featuring Bluetooth®, USB, Voice Control and emergency assistance. ICE pack 154	○	●	●	●	-	○	●	●	ICFFZ
DAB Radio with 6" TFT Touchscreen display, diversity antenna, four front speakers, MP3 capability and Ford SYNC 3, Voice Control, Apple CarPlay, Android Auto, Emergency Assistance**, hands-free calling, GPS, Bluetooth® and audible text messaging, 2x USB. Includes rear parking sensor and fixed rear view camera. ICE pack 10	○	○	○	○	●	○	○	○	ICFAL
DAB Radio with 6" TFT Touchscreen display and Satellite Navigation, four front speakers, MP3 capability and Ford SYNC 3 with Navigation Centre, Voice Control, Touchscreen, Apple CarPlay, Android Auto, Emergency Assistance**, hands-free calling, GPS, Bluetooth® and audible text messaging, 2x USB. Includes rear parking sensors and fixed rear view camera. ICE pack 9	○	○	○	○	○	○	○	○	ICFAK
Single slot CD player. Not available with Wireless charging. Must be ordered with ICE packs 9, 10 or 154 on Leader series at extra cost	○	○	○	○	○	○	○	○	IBPAC
Wireless charging pad. Not available with CD player. Compatible with devices that support Qi wireless charging	○	○	○	○	○	○	○	○	IEXAB
Climate control									
Air conditioning – Manual with smart recirculation function	○/□	○/□	●	-	-	○/□	○/□	○/□	AC--S
Air conditioning – Dual-zone Electronic Automatic Temperature Control (DEATC) with electronic recirculation facility (not available for DCiV)	-	○	○	●	●	-	-	-	AC--G
Interior lighting									
Courtesy lights – Front dome	●	-	-	-	-	●	-	-	JCFAF
Courtesy lights – Front dome light with two map-reading lights	-	●	●	●	●	-	●	●	JCFAC
Lights – Glovebox	-	-	●	●	●	-	-	-	JCLAB

Comfort and convenience

	VAN L1&L2					DCiV L1			MFC Code
	Leader	Trend	Limited	Sport	Active	Leader	Trend		
Seating									
Seat adjuster – Driver 2 way manual (fore/aft and recline)	●	-	-	-	-	●	-	-	BYPAB
Seat adjuster – Driver 4-way manual (fore/aft, recline and up/down)	○	●	●	●	●	○	●	●	BYPAD
Dual passenger seat. Must be ordered together with a bulkhead with a load through hatch	□	□	□	□	□	-	-	-	FS--G
Heated Drivers Seat	-	□	●	●	●	-	□	□	BYIAB
Heated passenger seat. Only with single passenger seat. (If dual seat option is taken the passenger seat is not heated)	-	□	●/-	●/-	●/-	-	□	□	
Instruments and controls									
Door mirrors – Manual door mirror	●	-	-	-	-	●	-	-	BSHA7
Door mirrors – Electrically-operated and heated	○	●	-	-	-	○	●	●	BSHAX
Door mirrors – Electrically-operated, autofold on lock and heated	-	○	●	●	●	-	○	○	BSHAZ
Electrically-operated, power fold heated door mirrors, with Blind Spot Information System. Self colour housing on Leader Trend and Active; Body colour housing on Limited and Sport. Includes Cross Traffic Alert	○	○	○	○	○	-	-	-	BSHEI/HLLAD
Large Door Mirrors with small secondary blind spot eliminator mirror	○	○	○	○	○	○	○	○	BSYAC
Electrochromic rear view mirror	□	□	□	□	-	□	□	□	
2-speed variable intermittent front wipers	●	●	-	-	-	●	●	●	CFFAB
Rain-sensing wipers (requires automatic headlight activation)	□	□	●	●	●	□	□	□	CFFAE
Rear window washer/wiper (can only be ordered with glazed rear windows)	○	○	○	○	○	○	○	○	CFEAB
Steering wheel – 4-spoke PU with black shells	●	●	-	-	-	●	●	●	GTAAJ
Steering wheel – 4-spoke leather (included with all cruise control variations on Base and Trend)	□	□	●	●	●	□	□	□	GTABU
Driver's window – Electrically-operated with one-touch lowering	●	●	-	-	-	●	●	●	B2CAG
Front windows – Electrically-operated with one touch up and down	-	□	●	●	●	-	□	□	B2CAF
Trip/fuel computer	●	●	●	●	●	●	●	●	HEBAD
Technology									
Quickclear heated windscreen (includes dual power heated mirrors on Leader)	□	●	●	●	●	□	●	●	B3MAB
MyKey	○	○	○	○	○	○	○	○	A64AB
Option Packs									
City Pack – Contains manual electric air conditioning and Speed Control with ASLD	○	○	-	-	-	○	○	○	AGJAB
Smokers' Pack	○	○	○	○	○	○	○	○	J3CAB

● = Standard, ○ = Option, at extra cost, □ = Part of an option pack, at extra cost. **L1** = Short wheelbase, **L2** = Long wheelbase. The Bluetooth® word mark and logos are owned by the Bluetooth SIG, Inc. and any use of such marks by Ford Motor Company is under licence. Other trademarks and trade names are those of their respective owners. **Ford Emergency Assistance is an innovative SYNC feature that uses a Bluetooth®-paired and connected mobile phone to help vehicle occupants initiate a direct call to the local Communications Centre, following a vehicle crash event involving an airbag deployment or fuel pump shut off. The feature operates in more than 40 European countries and regions.

Safety and security

	L1&L2					MFC Code
	Base	Trend	Limited	Sport	Active	
Safety						
Brake light – Rear high-mounted	●	●	●	●	●	JDDAB
Seat belts – Front, 3 point, with seat pre-tensioner, height adjust and load limiters	●	●	●	●	●	CPTAB
Seat belt minder – Driver	●	●	●	●	●	BY5AI
Airbag – Driver's	●	●	●	●	●	CPGAB
Airbag – Front passenger's* with deactivation via cluster	○/□	○/□	○/□	○/□	○/□	CPHAB/CPQAB
Airbags – Driver's and passenger's side airbag (side and thorax)	□	□	□	□	□	CPMAB/CPNAB
Windscreen – Infra-red, non reflective	●	●	●	●	●	B2RAK
Security						
Cargo vehicle unlocking – Stage 1: front row doors; stage 2: remaining doors (not available on Commercial Kombi, Optional on DCIV)	●/○	●/○	●	●	●	CB4AB
Locking – Auto relocking	●	●	●	●	●	CB1AB
Central Locking – Double locking	●	●	●	●	●	CBAAD
Keyless start system	–	–	●	●	●	CBGAJ
Remote key and plain key	●	●	–	–	–	CADAE/CBFAB
Two remote keys (no plain key included as part of this pack)	○/□	○/□	●	●	●	CADAF/CBFAK
Fleet key (consists of additional plain key)	○	–	–	–	–	CATAB
Perimeter anti-theft alarm	○	○	–	–	–	HNAAD
Thatcham Category 1 alarm	○	○	●	●	●	HNAAG
Security – Passive Anti-Theft System (PATS)	●	●	●	●	●	HNDAF
Brakes						
Power 4-wheel disc	●	●	●	●	●	FBAAD
Emergency Brake Warning (automatic flashing of brake lights under heavy braking)	●	●	●	●	●	FCCAB
Side Wind Stabilisation	○	○	○	○	○	FEAA2
Anti-lock braking system (ABS) with electronic brake-force distribution (EBD) and Electronic Stability Control (ESC)	●	●	●	●	●	FEAAN
Emergency Brake Assist (EBA)	●	●	●	●	●	FCBAD

● = Standard, ○ = Option, at extra cost, □ = Part of an option pack, at extra cost. **L1** = Short wheelbase, **L2** = Long wheelbase.

***Note: A rear-facing child seat should never be placed in the front passenger seat when the Ford vehicle is equipped with an operational front passenger's airbag.**

Utility

	L1&L2					DCIV		
	Base	Trend	Limited	Sport	Active	Base	Trend	MFC Code
Body								
Kerbside load doors	●	●	●	●	●	●	●	A4LAB
Dual side loading doors	○	○	○	○	○	●	●	A4LAC
Unglazed rear cargo doors (hinged)	●	●	●	●	●	●	●	A6KAB/A6LAD
Heated, glazed tailgate	○	○	–	–	–	○	○	A6KAC/AALNP
Second row fixed window	–	–	–	–	–	○	○	B3BAC/B3AAC
Driver's windows – Electrically-operated with one-touch lowering	●	●	–	–	–	●	●	B2CAG
Front windows – Electrically-operated with one-touch up and down	○/□	○/□	●	●	●	–	○	B2CAF
Carpet and trim								
Floor mats – All-weather	○	○	○	○	○	○	○	FIDAE
Floor cover – Rubber	●	●	●	●	●	●	●	BBKAC
Interior grab handles – Front	●	●	●	●	●	●	●	BEJAK
Electrical								
12 V power point, single – Located in floor console (not available on Commercial Kombi)	●	●	●	●	●	●	●	J3AAB
12 V power point – Located in instrument panel	●	●	●	●	●	●	●	J3EAF
12 V power point – Located in the load compartment	–	○	○	○	○	–	○	J3FAD
230 V power inverter	○	○	○	○	○	○	○	HUKAD
Wireless charging station (not available with single CD player)	○	○	○	○	○	○	○	IEXAB
Device dock	○	–	–	–	–	○	–	C2PAB
Heavy-duty battery	○	○	○	○	○	○	○	HTAAC

● = Standard, ○ = Option, at extra cost, □ = Part of an option pack, at extra cost. **L1** = Short wheelbase, **L2** = Long wheelbase.

Utility

	L1&L2					DCIV			MFC Code
	Base	Trend	Limited	Sport	Active	Base	Trend		
Exterior functional									
Towing hooks – Front and rear	●	●	●	●	●	●	●		-
Fixed tow bar – Allows quick installation of a tow bar. Includes Trailer Sway Control and pre-assembled trailer light module (13-pin e-Kit is required)	○	○	○	○	○	○	○		C1DAB
Detachable (includes 13-pin connector and Trailer Sway Control)	○	○	○	○	○	○	○		C1MAC
Towing Pre-pack	○	○	○	○	○	○	○		C1QAB
Loadspace compartment									
Load floor liner (not available on DCIV and Commercial Kombi)	○	●	●	●	●	-	-		BDIAJ
Load floor cover (not available for Van)	-	-	-	-	-	●	●		BDIAU
Cargo tie down hooks	●	●	●	●	●	●	●		-
Bulkhead – Moveable full width, full-height mesh (DCIV/Commercial Kombi NI only)	-	-	-	-	-	●	●		A6AAU
Bulkhead – Full width steel, full height (available for Van only) (Not available with dual passenger seat)	●	●	●	●	●	-	-		A6AAC
Bulkhead – Full width steel no hatch, with fixed window (available for Van only) (Not available with dual passenger seat)	○	○	○	○	○	-	-		A6AAF
Bulkhead – Full width steel with loadthrough hatch (available for Van only with dual passenger seat)	○	○	○	○	○	-	-		A6AA3
Bulkhead – Full width steel with loadthrough hatch and fixed window (available for Van with dual passenger seat)	○	○	○	○	○	-	-		A6AA4
Complete rear trim board (Van only)	●	●	●	●	●	●	●		BBAAD
Option Packs									
Bulkhead Removal Pack (Van only)	○	-	-	-	-	○	-		AGRAE/AGRAF/ AGRAG/AGRAH/ AGRAJ

● = Standard, ○ = Option, at extra cost, □ = Part of an option pack, at extra cost. **L1** = Short wheelbase, **L2** = Long wheelbase.

Special Vehicle Options

	L1&L2						MFC Code
	Base	Trend	Limited	Sport	Active		
Body							
Carpet and trim							
Load floor covering removal (for Van only)	●/□	○/□	-	-	-		BDIAA
Options Packs							
SVO pack 1 – Contains ICE Pack 30 (pre-equipment pack – two front speakers and two rear speakers, no radio) and autowipers (for Van only)	○	-	-	-	-		AALA6
Sortimo Van Pack – Contains single side racking and safety floor (for Van only)	○	○	-	-	-		AALA7
Glazed tailgate Pack – Contains heated glazed tailgate (for DCIV only)	○	○	-	-	-		AALNP
Wheel chair Access Conversion Pack (Van only)	○	○	○	○	○		AALNR
Upfitter Preparation Pack – Contains repositioned Adblue® tank for wheelchair access vehicle conversions (Commercial Kombi NI & M1)	○	○	-	-	-		AGAAW
Paint							
Special paint, 50 colours available, consult Dealer for details** (contains self colour rear bumper end caps and self colour front bumper)	○	○	-	-	-		AB7AB

● = Standard, ○ = Option, at extra cost, □ = Part of an option pack, at extra cost. **L1** = Short wheelbase, **L2** = Long wheelbase.

**SVO paint suffix must be entered at time of ordering.

5

OWNERSHIP

Getting behind the wheel of your next new Ford is simple, with a variety of finance options available to suit your business needs.



Build your vehicle

Build and personalise your vehicle online. Simply head to the Ford website, select your model, then choose your engine, body colour and extras. You'll be able to view the recommended price, and send your configuration to a Ford Commercial Vehicle Dealer if you wish.

www.ford.co.uk



Find a Dealer and request a test drive

You can search for a Ford Commercial Vehicle Dealer by location or Dealer name on the Ford website, and request a test drive online. Simply fill in your details and your chosen Dealer will contact you to arrange a convenient time.

www.ford.co.uk



Commercial Vehicle Finance

When it comes to financing your Ford Commercial Vehicle, our size and expertise means we're well placed to provide you with a wide range of finance products.

Ford Credit[®]: Provides a range of finance plans for Commercial Vehicle customers interested in owning their vehicle.

Ford Lease[†]: Specialises in contract hire and leasing, and provides an alternative range of finance plans which can be tailored to suit your business. Business users only.

For more information about our finance products visit www.ford.co.uk



FordPass Pro

Look after up to five business vehicles, with tools to help you keep them healthy, secure and running smoothly. So you can focus on the work.

FordPass Pro is designed for new Commercial Vehicles that come with FordPass Connect. Our built-in modem keeps you effortlessly connected with your vehicles, wherever you are. Giving you all the features you need to keep your business moving.

FordPass Pro is available in selected markets. Please see your Ford Dealer for details.

Download FordPass Pro from the App Store or get it on Google Play.

Important information:

[®]Ford Credit: Finance subject to status. Guarantees may be required. Freepost Ford Credit.

Ford Credit is a trading style of FCE Bank plc, which is authorised by the Prudential Regulation Authority and regulated by the Financial Conduct Authority and Prudential Regulation Authority under firm reference number 204469.

[†]Ford Lease: Ford Lease is provided by ALD Automotive Ltd., trading as Ford Lease, Oakwood Park, Lodge Causeway, Fishponds, Bristol, BS16 3JA. ALD Automotive is registered in England No. 987418. For the purposes of the Data Protection Act 1998 the data controllers in relation to any information you supply are Ford Motor Company Limited, FCE Bank Plc and ALD Automotive. Finance subject to status. Guarantees and indemnities may be required. ALD Automotive is authorised and regulated by the Financial Conduct Authority.

5 OWNERSHIP PROTECT

Ford Business Service

Efficiency, accuracy and convenience are at the heart of the Ford Transit²⁴ Commercial Vehicle service promise. Therefore, whether it is servicing, maintenance or repair you need, be sure to come and see us.

- Available from all Transit Centres and Transit Service Dealers
- While-you-wait servicing by prior appointment
- Late night servicing available at least once per week
- Priority treatment for urgent repairs
- Vehicle off the road repairs (VOR)*
- Collection and delivery**
- Testing and MOTs
- Transparent pricing
- Genuine Ford parts quality
- Ford-trained technicians
- Interim checks for optimum vehicle performance
- Service Activated Roadside Assistance†
- Ford Protect packages to suit you
- One Call to access all the Ford services you need

For more information and to find your nearest participating Ford Commercial Vehicle Dealer, visit the aftersales support section at www.ford.co.uk/transit24

Service Plans

Save on your servicing costs

A Ford Protect Service Plan[†] fixes your servicing costs at today's prices for the duration of your plan, helping you save money.

Simply select the Ford Protect Service Plan that is most appropriate to your needs, with 2, 3 and 4 year plans available. Ford Protect Service plans can be paid for upfront, or if you buy online through the Ford Online Shop, the costs can be spread into convenient and affordable monthly payments. www.shop.ford.co.uk/pages/service-plans

If you are looking for even more peace of mind, the Ford Protect Service Plan Plus includes everything already covered by the Ford Protect Service Plan, with the addition of Wear and Tear parts. All work on your vehicle will be undertaken by a Ford authorised repairer. Available through your Ford Dealer at point of registration only.

Ford Protect Service Plans must be purchased before the vehicle is 12 months old or before its first service. They are transferable to the new owner should you decide to sell your vehicle. Your Ford dealer will be happy to advise you on a plan which is tailored to your needs.

The duration of a Ford Protect Service Plan begins at the New Vehicle Warranty commencement date (usually the date of first registration). The length of your contract and your estimated mileage determines the number of services in a Ford Protect Service Plan.

Ford Protect

Commercial Extended Warranty

Cover your vehicle beyond the new vehicle warranty up to 5 years with Ford Protect. Available at participating Ford Dealers.

By extending your standard 3-year warranty, you will enjoy worry-free operation for many years to come. Ford Protect provides a range of key benefits, including:

- Extended duration and mileage
- Cover against unexpected repair costs
- Coverage on trips abroad
- Protection against inflation for the price of parts and labour for the length of your plan
- Transferable to the next owner
- Helps protect your vehicle resale value

Ford Protect terms and conditions apply.

For further information please call

03702 416 726, option 2, option 2.

*Repairs will start on the same working day (as long as you bring your vehicle in before 3pm), or at least within 24 hours of its arrival. If we need to order parts, we'll begin work the day they're delivered. 'Vehicle off the road' repairs should be completed within 24 hours.

**Your Transit Centre can arrange to collect your vehicle and deliver it back to you after service or repairs, so you can get on with running your business. By arrangement and limited to a specific mileage radius of the Dealer. Contact your local Dealer to discuss your requirements.

†Available at participating Dealers only. Roadside Assistance is activated automatically at every routine service with coverage extended valid from the date of service for 12 months. See Ford.co.uk/roadsideassistance for more information.

FOR MORE INFORMATION ON THE TRANSIT FAMILY, VISIT WWW.FORD.CO.UK



Illustrations, descriptions and specifications. This catalogue was correct at the time of going to print. However, Ford policy is one of continuous product development. The right is reserved to change specifications, colours and recommended prices of the models and items illustrated and described in this publication at any time. For the latest details always consult your Ford Dealer. **Optional equipment.** Throughout this publication, wherever a feature is described as being an 'Option' or 'Option Fitment/Pack' etc, you should assume that it will be at extra cost to the base vehicle, unless specifically stated to the contrary. All models and colour combinations are subject to availability. **Note.** Some images portrayed are of a pre-production model and/or are computer generated, therefore, the design/features on the final version of the vehicle may differ in various respects. In addition, some of the features shown on the vehicles may be optional. **Note.** This brochure contains both original Ford accessories as well as a range of products from our suppliers. Fitment of accessories may have an impact on your vehicle's fuel consumption. † The identified accessories are carefully selected third party supplier branded accessories which do not come with a Ford warranty but are covered by the third party supplier's own warranty, the details of which can be obtained from your Ford Dealer. **Note.** The Bluetooth® word mark and logos are owned by the Bluetooth SIG, Inc. and any use of such marks by Ford Motor Company is under licence. The iPod word mark and logos are the property of Apple Inc. Other trademarks and trade names are those of their respective owners. **Note.** Some driver assistance features and safety features described in this brochure are designed to function using sensors, whose performance may be affected under certain weather or environmental conditions.

The Government fuel figures do not express or imply any guarantee of the fuel consumption of any particular vehicle. The vehicles themselves have not been tested and there are inevitably differences between individual vehicles of the same model. In addition, a vehicle may incorporate particular modifications. Furthermore, the driver's style and road and traffic conditions, as well as the extent to which the vehicle has been driven and the standard of maintenance, will affect its fuel consumption. **Insurance groups** are only as recommended by the Association of British Insurers. You should always consult your insurance adviser for confirmation.

Ford One Call

In the unlikely event that your Ford Dealer can't help you or if you need to speak to us directly, call 0203 564 4444

Ford Rental – local service nationwide

Car and Van rental from our latest model range. Contact your local Ford Dealer for more information

Ford Motability

Call our Ford Motability team on 0345 6040019

Finance

Ford Credit Customer Services 0345 712 5490.
Ford Lease Customer Services 0344 600 1405
Calls to 0344 and 0345 numbers are charged at the same rate as a standard 01 or 02 geographic number, even when calling from a mobile.



Ford and BP – working together to reduce fuel consumption and emissions.

Published by Ford Motor Company Limited, Laindon, Essex, England. Registered in England No. 235446.

FA 1590/9
BJN 208084. FoE H60E
0621/GBR en
June 2021.

© Ford Motor Company Limited.

MY 2021.75 GBR en

INTERNATIONAL
engine
POWERTRAIN
of the year awards 2019
Presented by engine + powertrain technology international magazine

Sub 150 PS
Ford 1.0 litre EcoBoost

WWW.FORD.CO.UK

